

**DREVONA®**  
S Y S T E M**Michaela  
MD-3**

|  |      |
|--|------|
|  | 476  |
|  | 1436 |
|  | 18   |

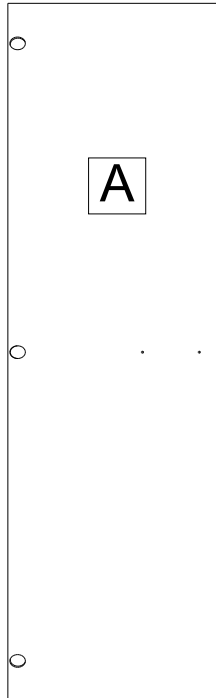

|                          |     |
|--------------------------|-----|
| 1                        |     |
| skrutka zh<br>3,5x16     | 6ks |
| 2                        |     |
| záves naložený<br>tlmený | 3ks |
| 3                        |     |
| podložka<br>závesu       | 3ks |
| 4                        |     |
| Úchytka Sisa<br>128mm    | 1ks |
| 5                        |     |
| Skrutka<br>4x22          | 2ks |

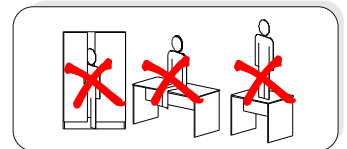
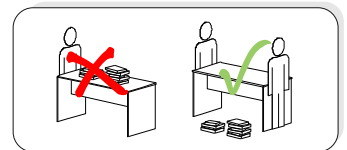
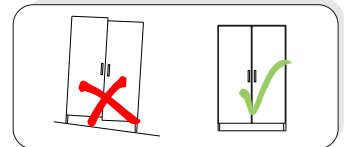
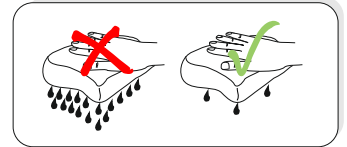

1.

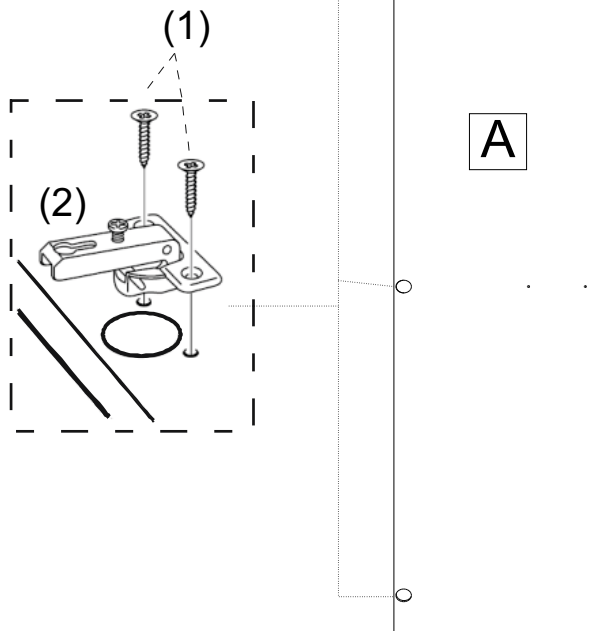

2.

M-02,03,04,05

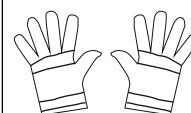
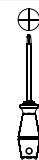
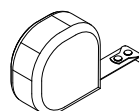
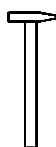
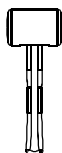
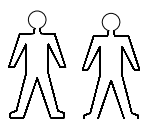
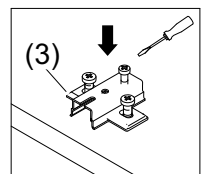
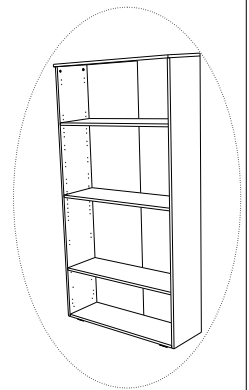
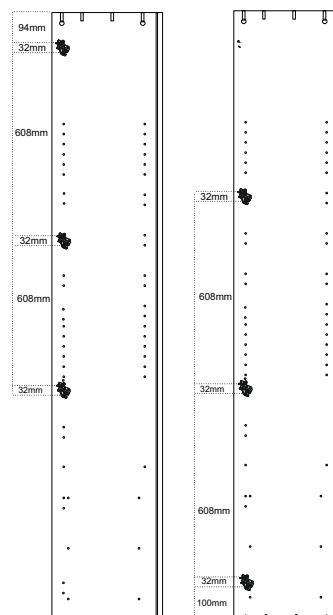

4.

