

**DREVONA**  
S Y S T E M**Michaela  
M-18**

	900
	1962
	900

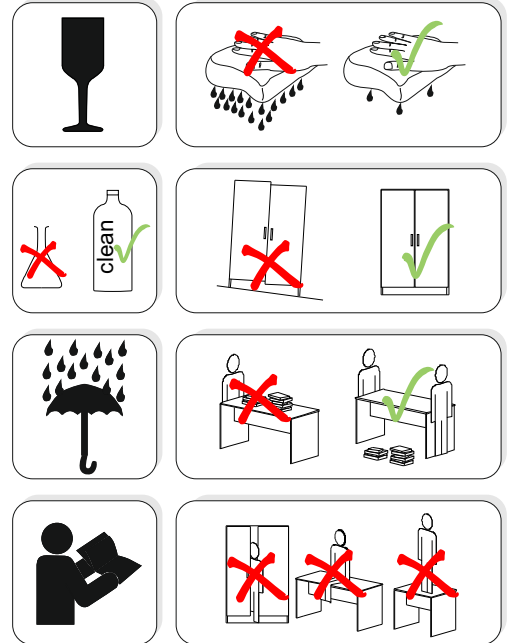

1	2	3	4	5	6	7
tiahlo 28ks	excenter 36ks	kolík 8x35 19ks	krytka 36ks	kolík 8x60 3ks	tiahlo obojstranné 4ks	Skrutka ZH 3,5x16 4ks
8	9	10	11	12	13	14
uchyt veš. tyč 2ks	klizak Herman 6ks	skrutka zh 5x25 12ks	Kliniec 1,2x25 8ks	narážací excenter 6ks	kolík DU 322 (tiahlo) 6ks	Veš.tyč 855mm 1ks
19	20	21				
chrbatova spojka 20ks	skrutka zh 3x20 20ks	podpera policova 5/5 16ks				

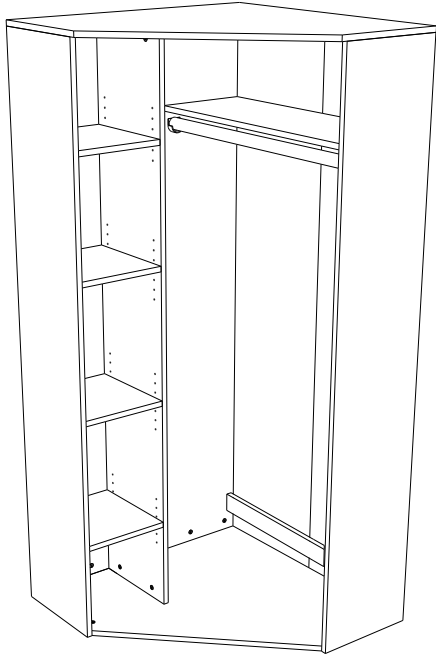
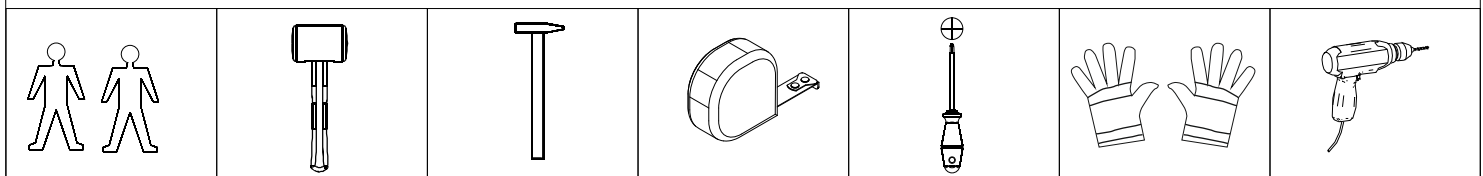

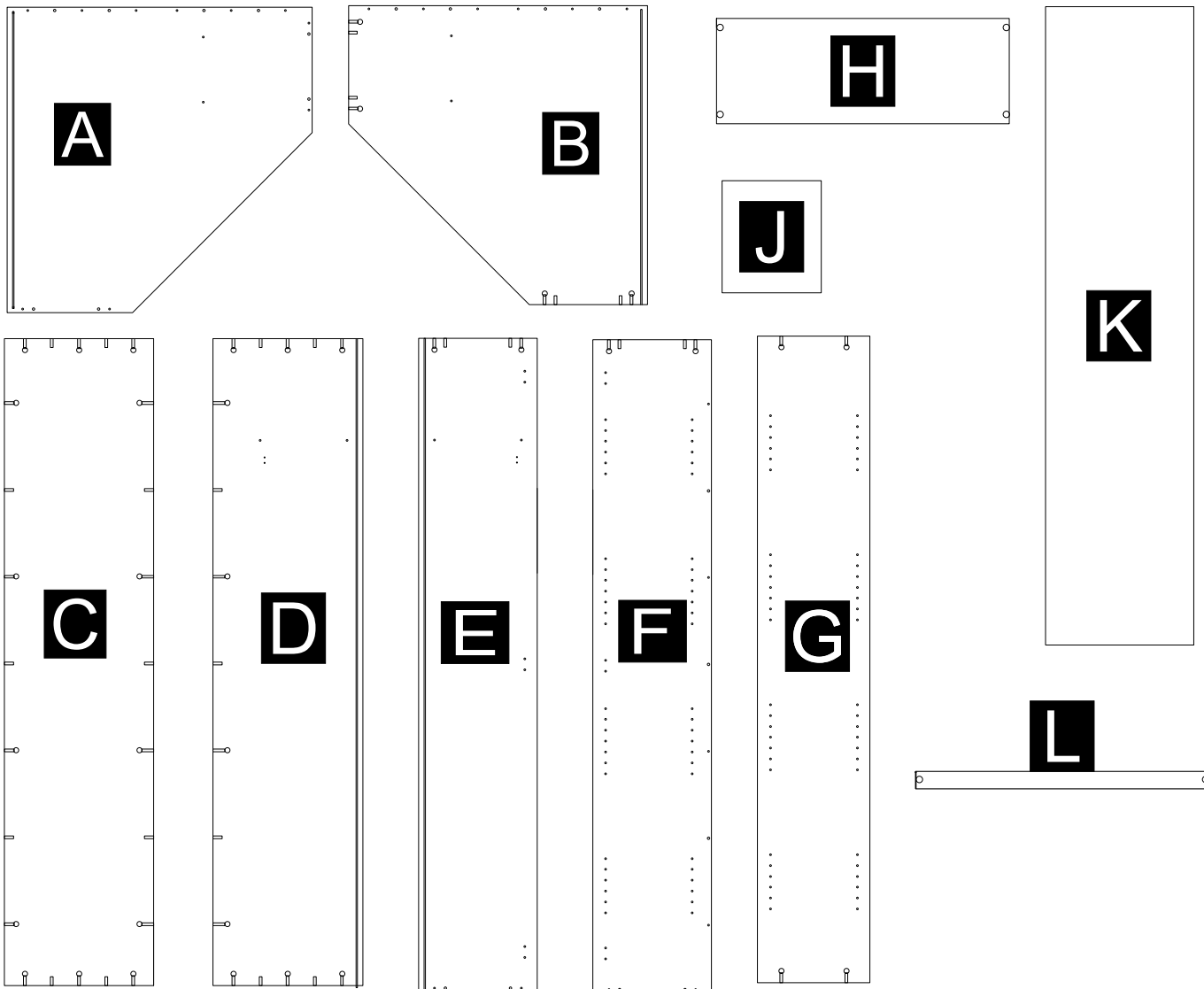

diel	hr	š	d	ks
A	18	900	900	1
B	18	881,5	881,5	1
C	18	440	1907	1
D	18	441,5	1907	1
E	18	350	1925	1
F	18	350	1925	1
G	18	331,5	1907	1
H	18	310	863	1
J	18	330	293	4
K	3	437	1917	2
L	18	60	863	1

1

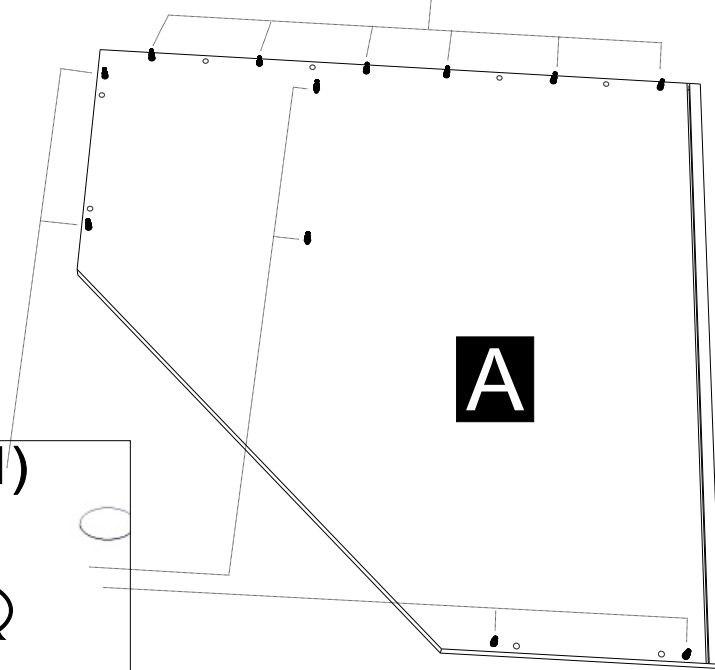
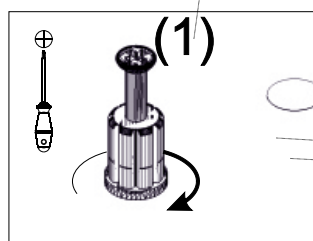
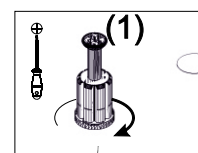

2.

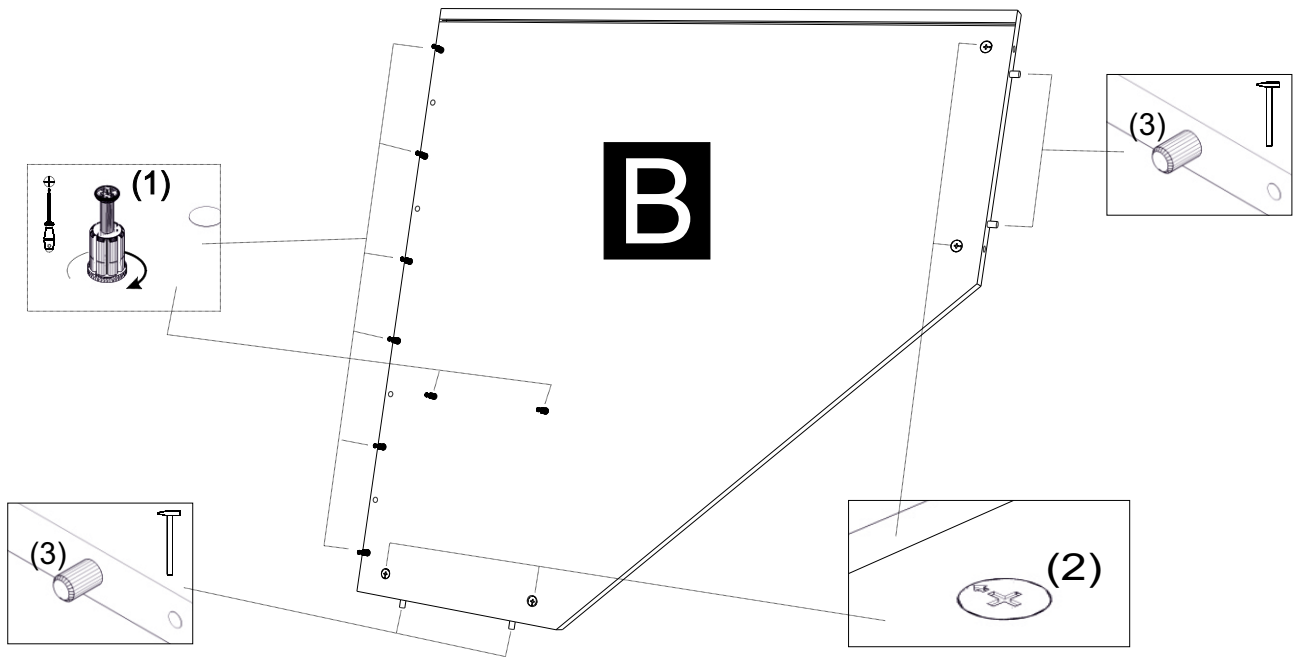

3.

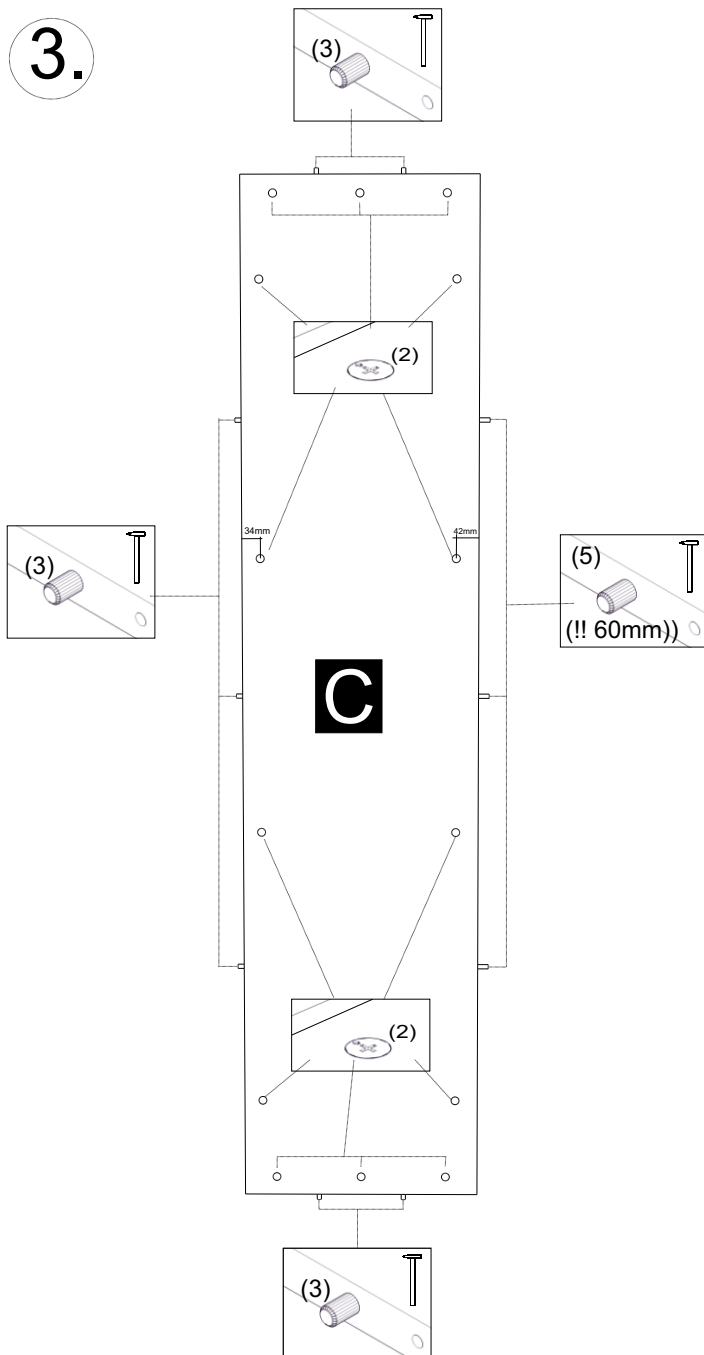

4.

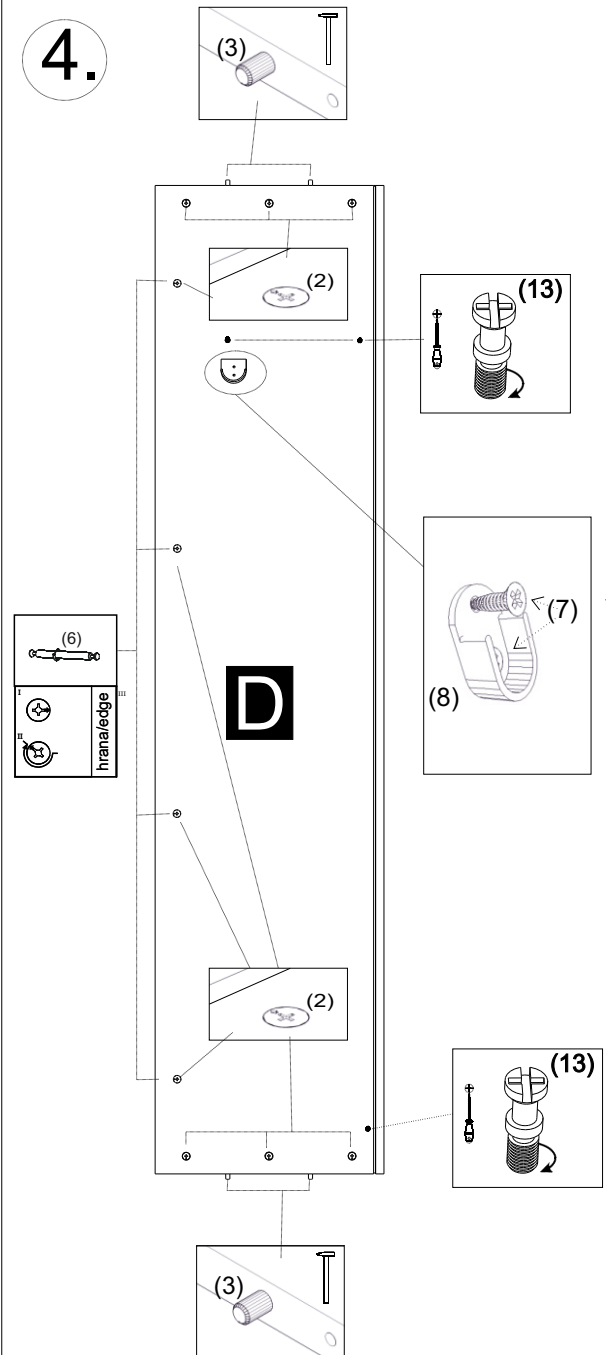

5.

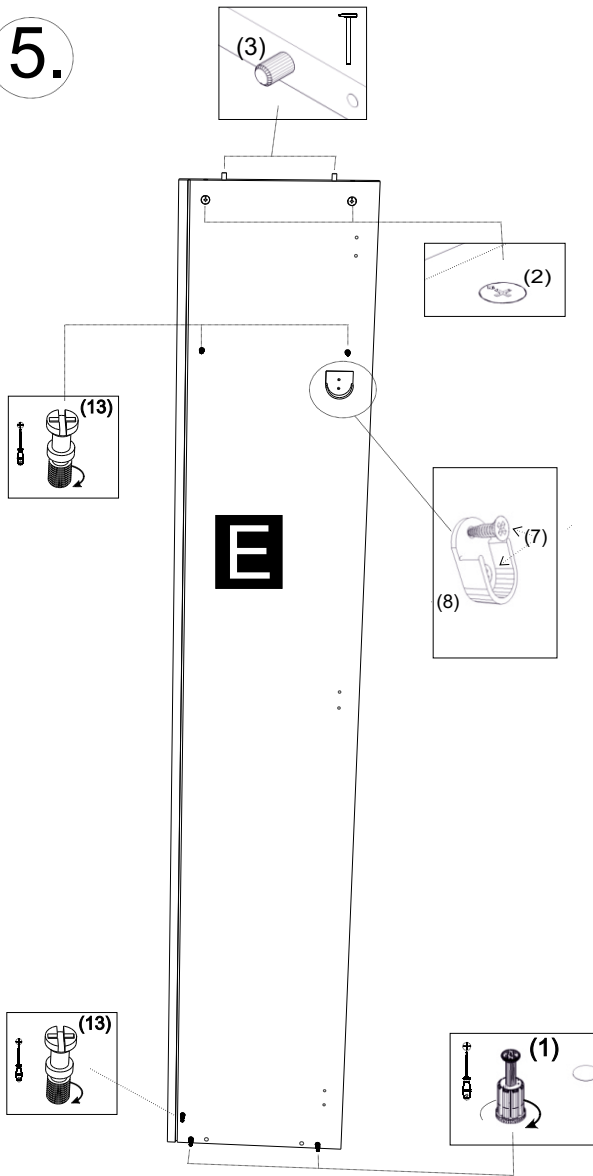

6.

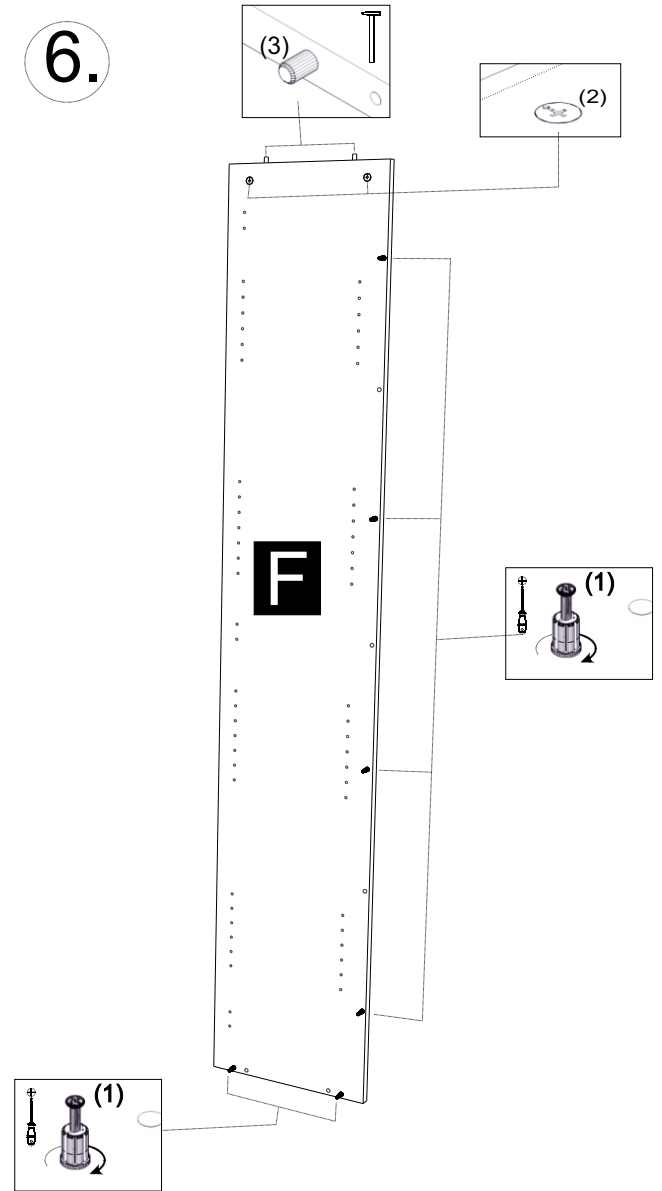

7.

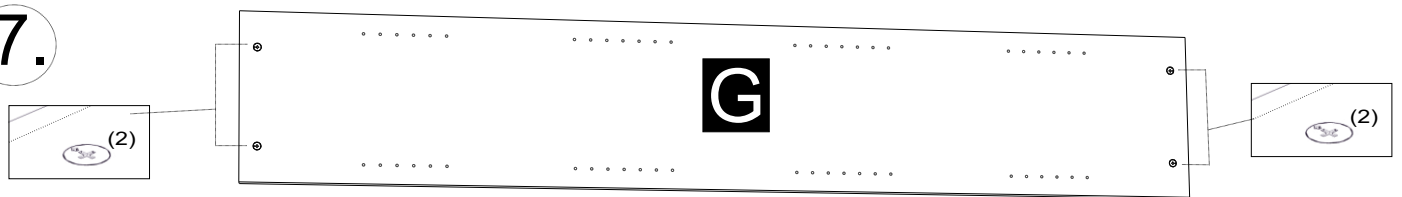

8.

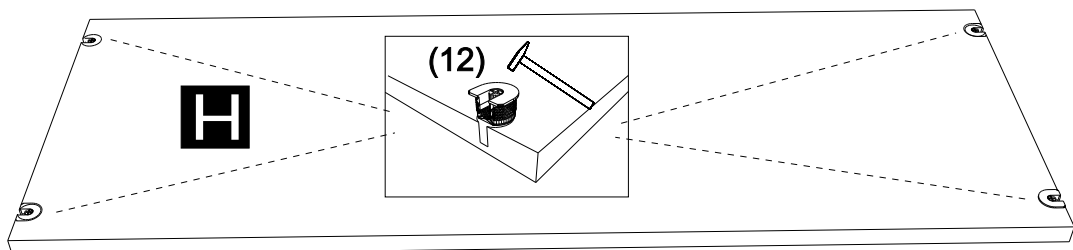

9.

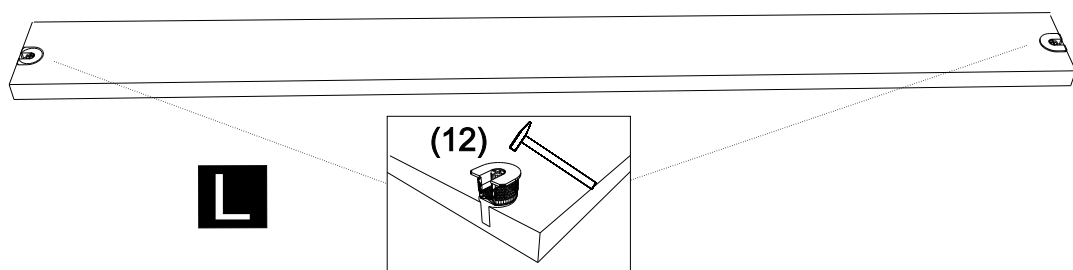

10.

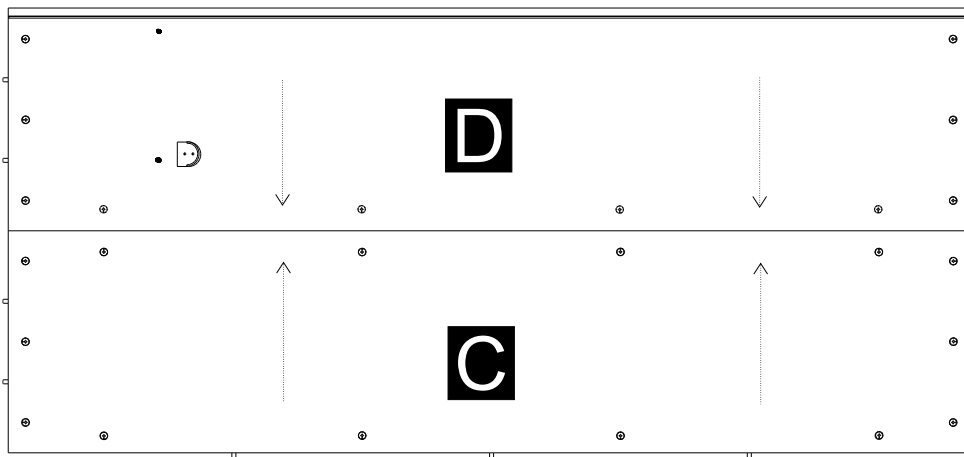
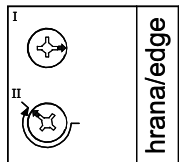

11.

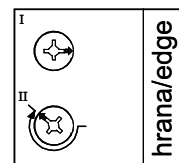
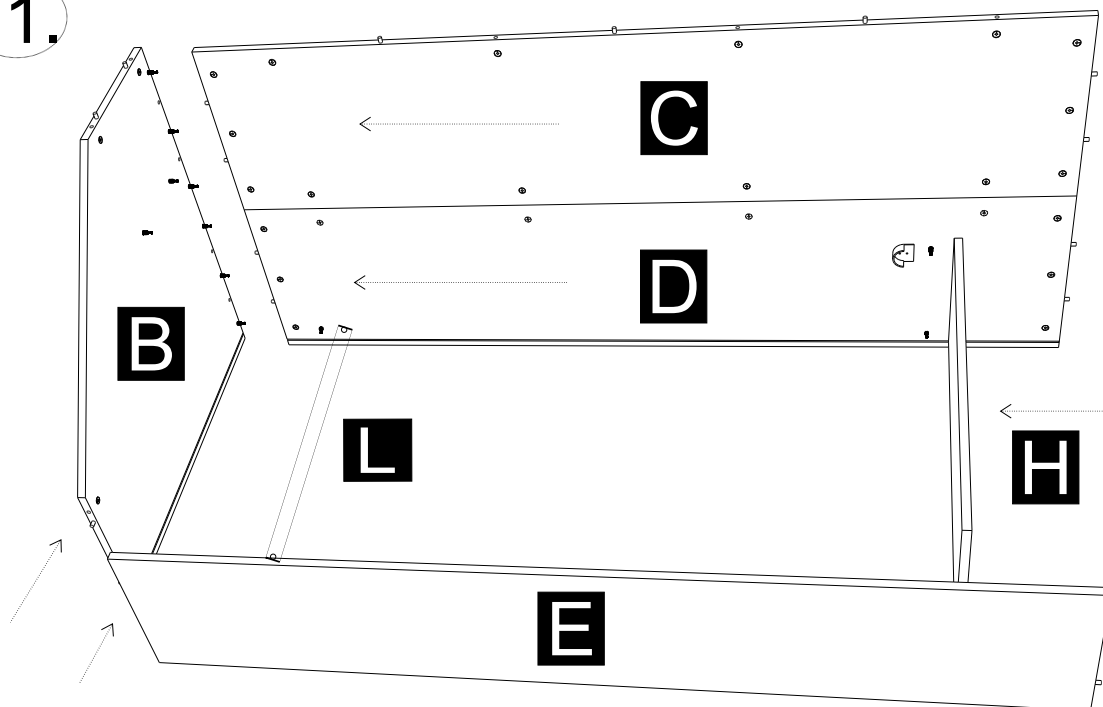

12.

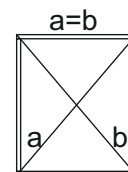
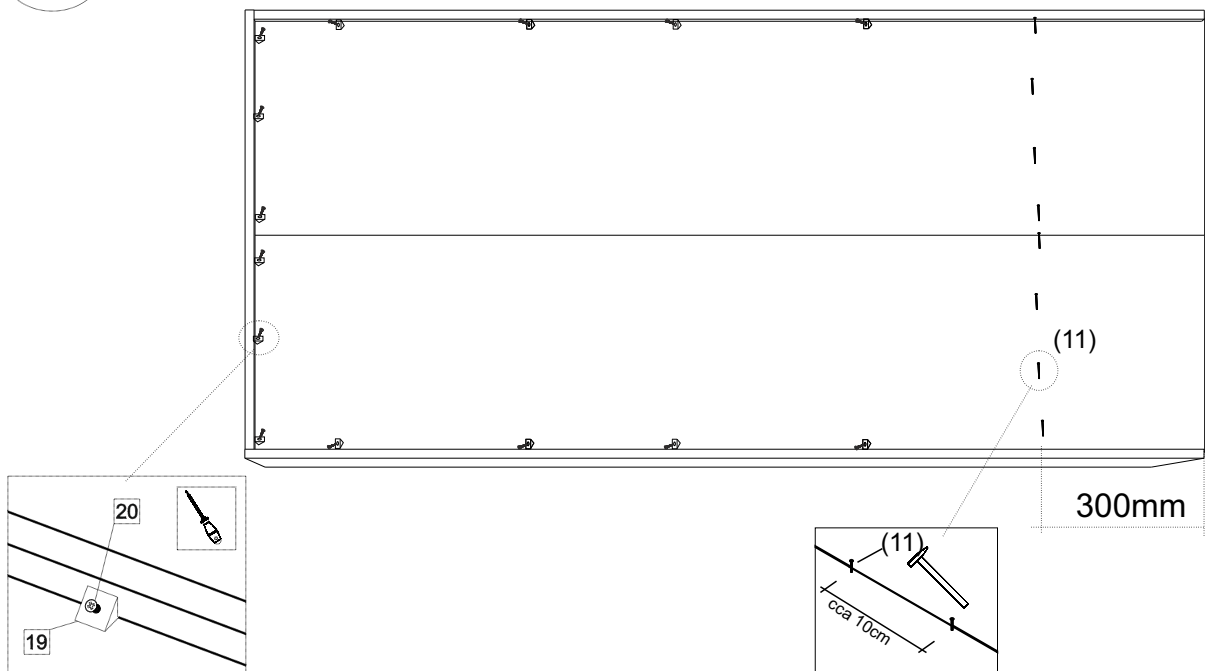

13.

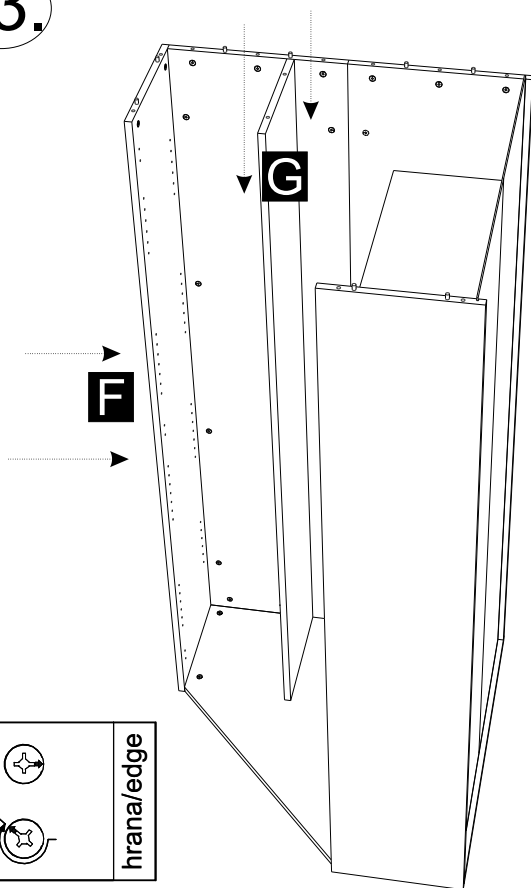

14.

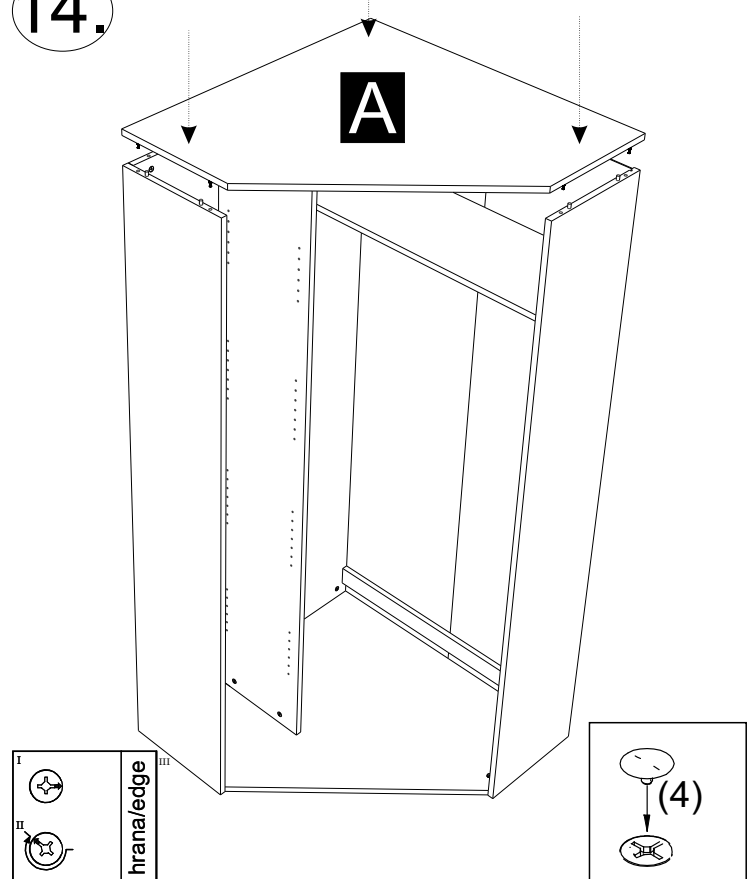

15.

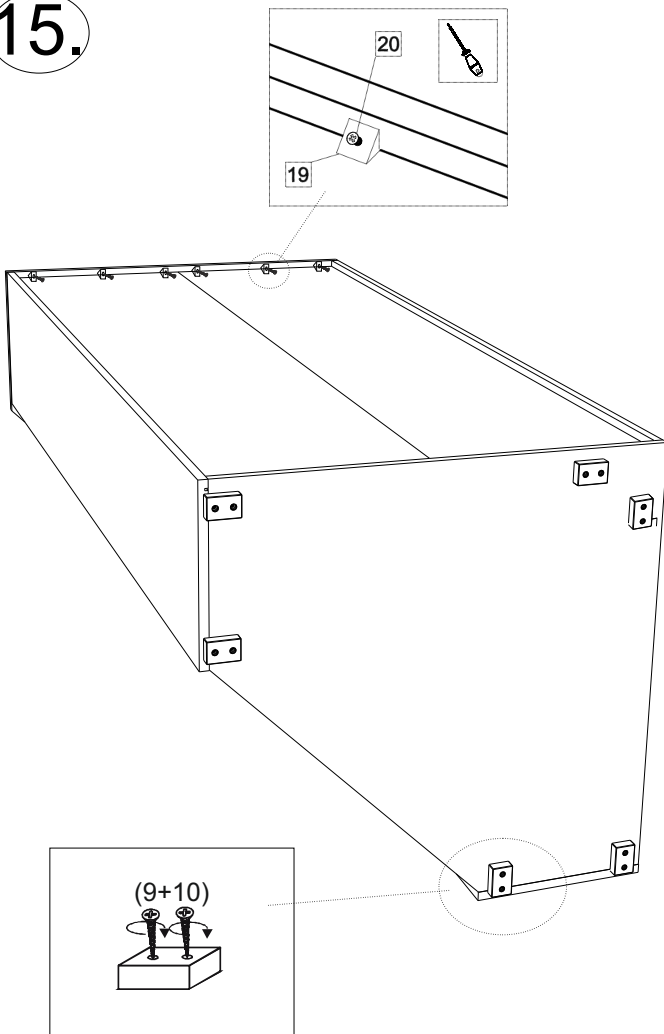

16.

