

DREVONA®
S Y S T E M**Michaela**
M-02

| | |
|--|------|
| | 960 |
| | 1962 |
| | 370 |

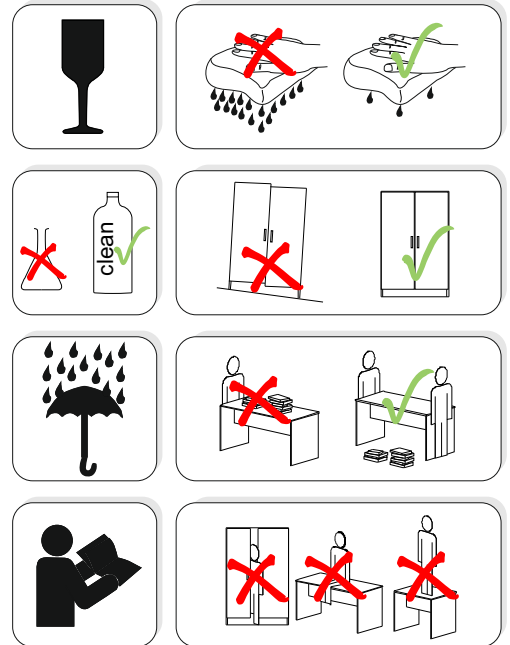

| | | | | | | | | | | | | | |
|-----------------|------|-----------------|-----|---------------|------|--------------|-----|-------------------|------|----------------------|------|------------------|------|
| 1 | | 2 | | 3 | | 4 | | 5 | | 6 | | 7 | |
| ťahlo | 8ks | excenter | 8ks | kolík 8x35 | 8ks | krytka | 4ks | skrutka ZH 5x50 | 1ks | bezpečnostný uholník | 1ks | hmoždina D 10 | 1ks |
| 8 | | 9 | | 10 | | 12 | | 13 | | 14 | | 19 | |
| skrutka zh 3x20 | 14ks | skrutka zh 5x25 | 8ks | klinec 1,2x25 | 40ks | kĺzak Herman | 4ks | narážací excenter | 12ks | kolík DU 322 (ťahlo) | 12ks | chrbatova spojka | 14ks |
| 20 | | | | | | | | | | | | | |
| skrutka zh 4x16 | 1ks | | | | | | | | | | | | |

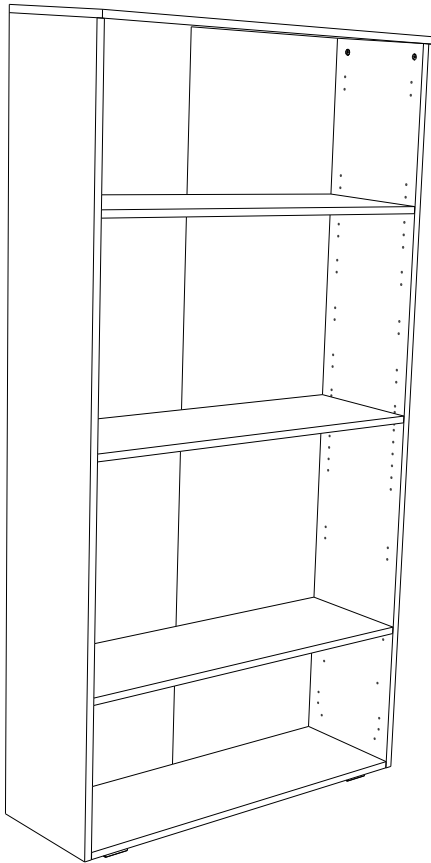
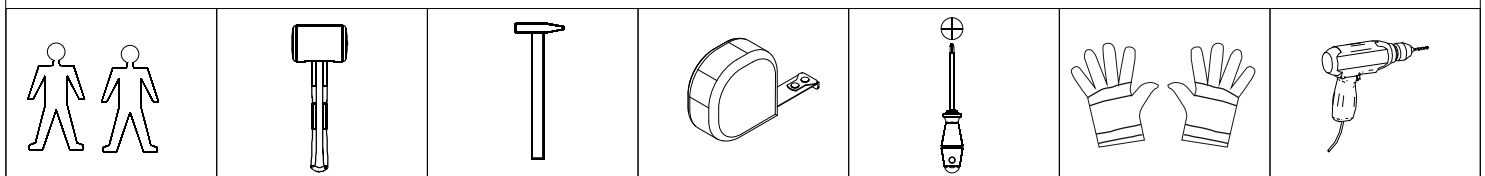

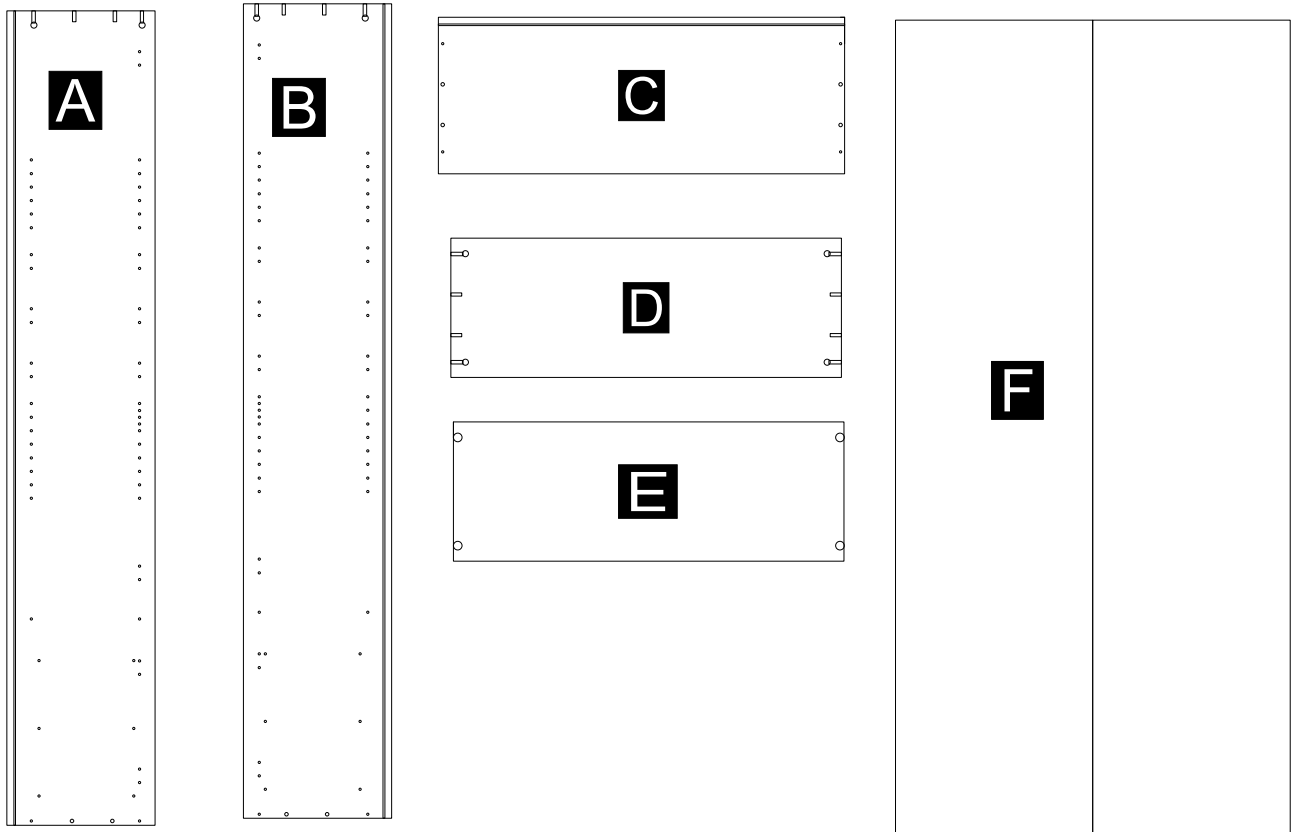

| diel | hr | š | d | ks |
|------|----|-------|------|----|
| A | 18 | 350 | 1925 | 1 |
| B | 18 | 350 | 1925 | 1 |
| C | 18 | 370 | 960 | 1 |
| D | 18 | 329 | 923 | 1 |
| E | 18 | 329 | 923 | 3 |
| F | 3 | 466,5 | 1929 | 2 |

Kombinácia dvierok osadenie polic

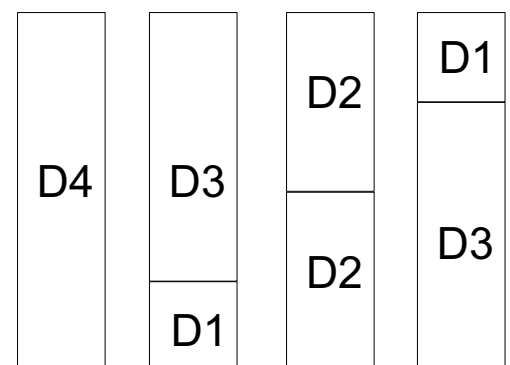
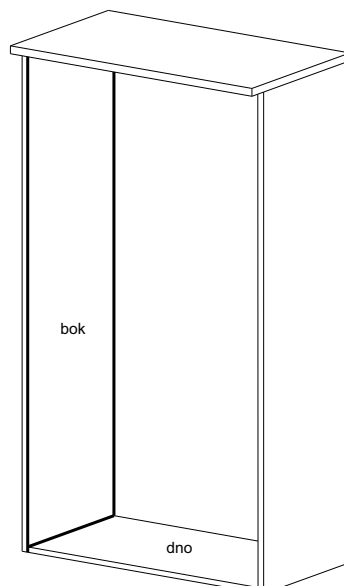
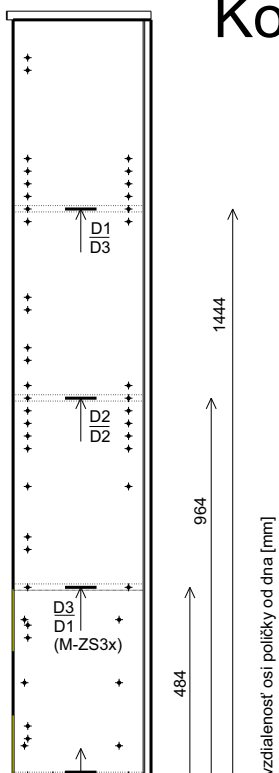

dvierka

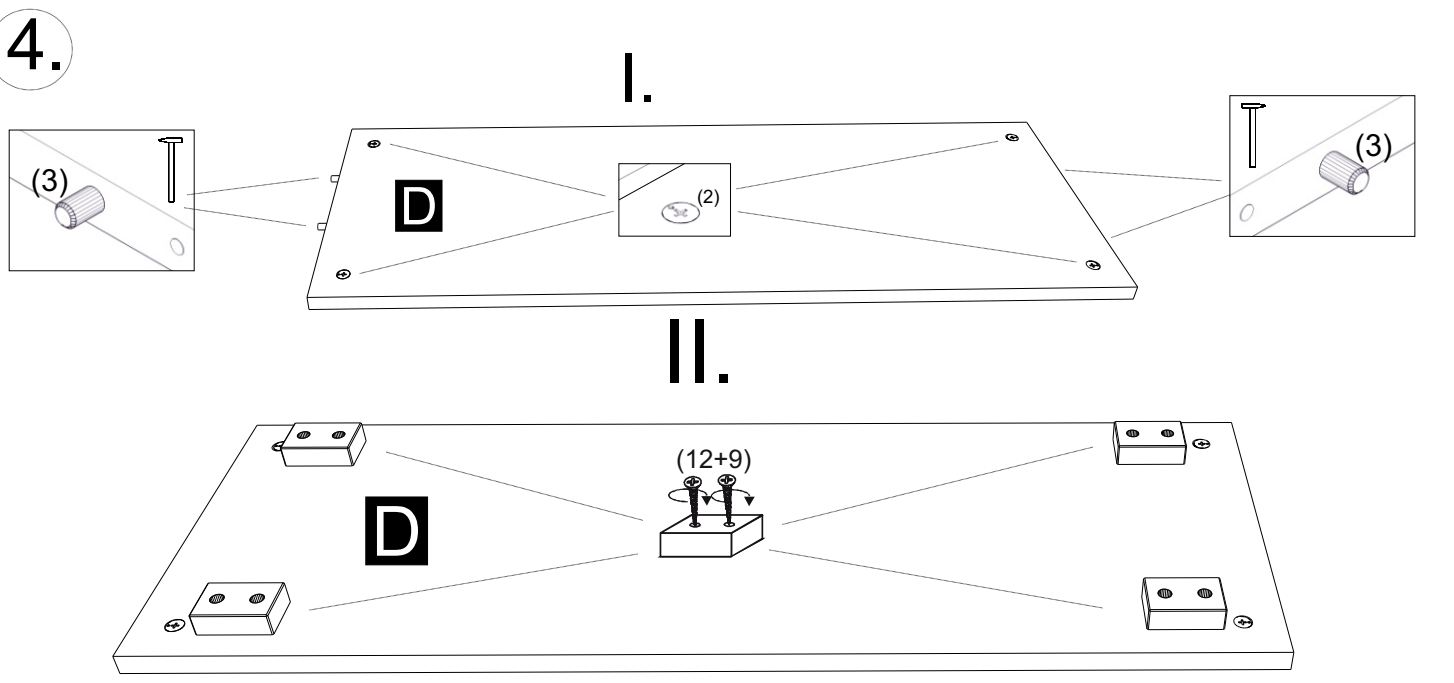
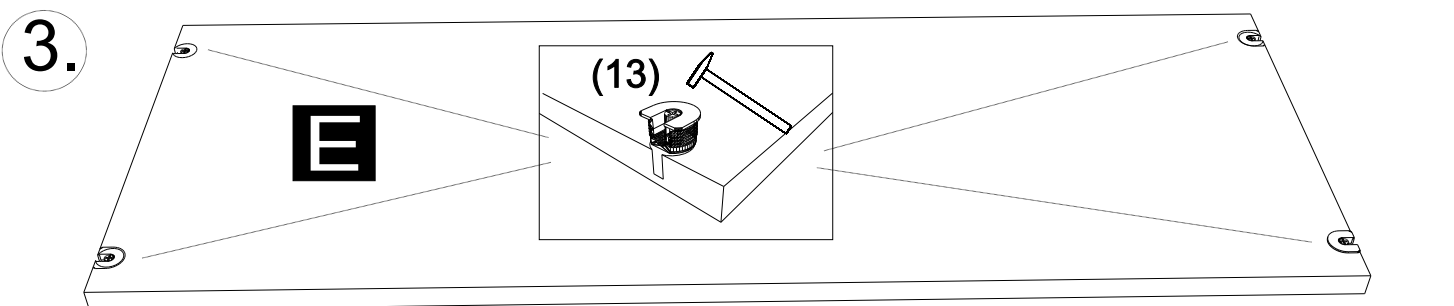
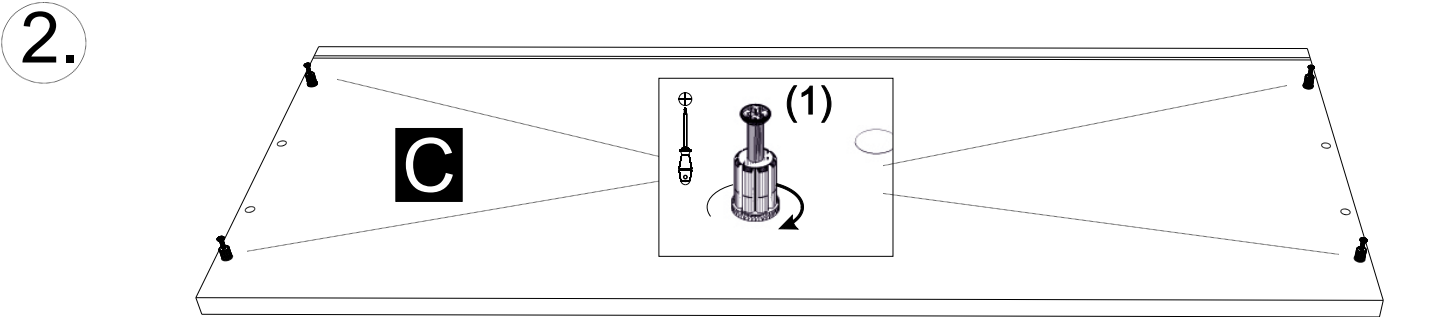
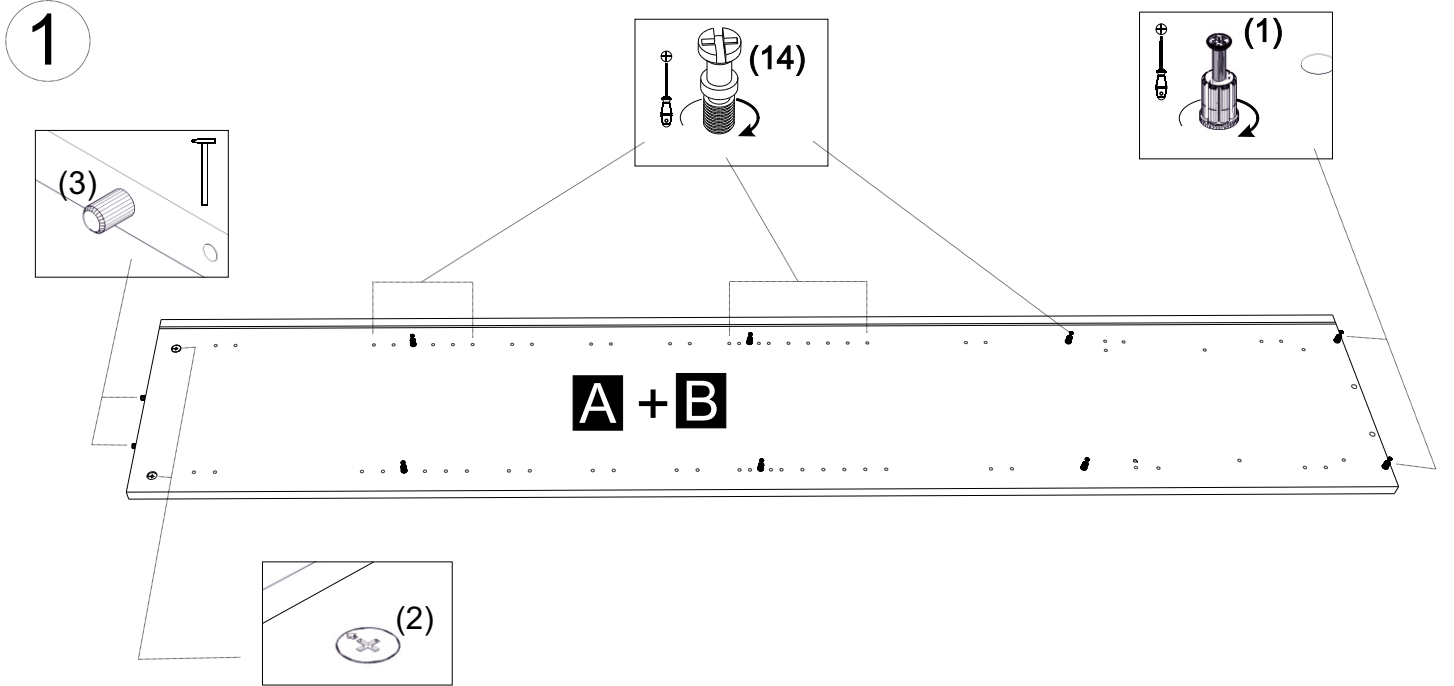

5.

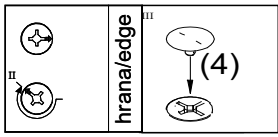
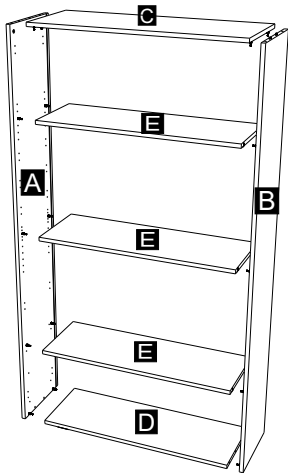

6.

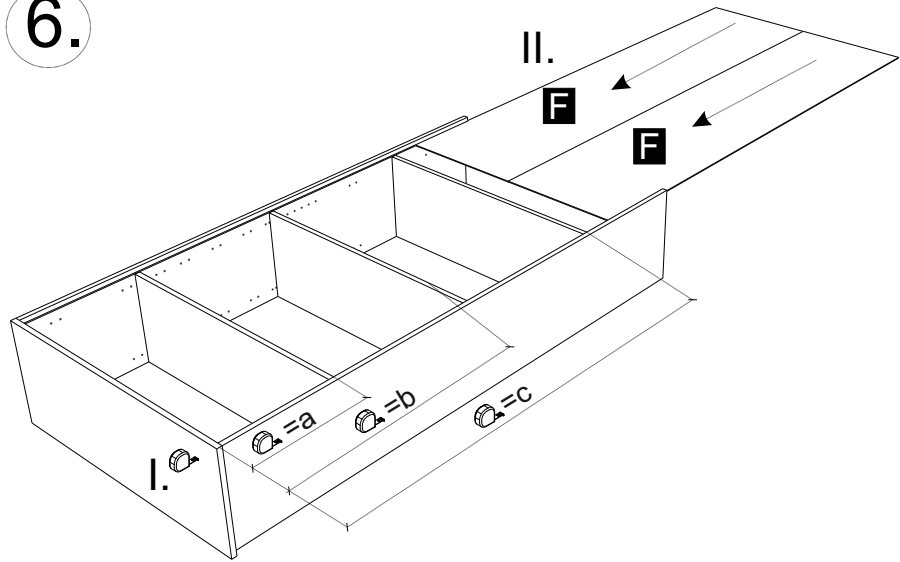

7.

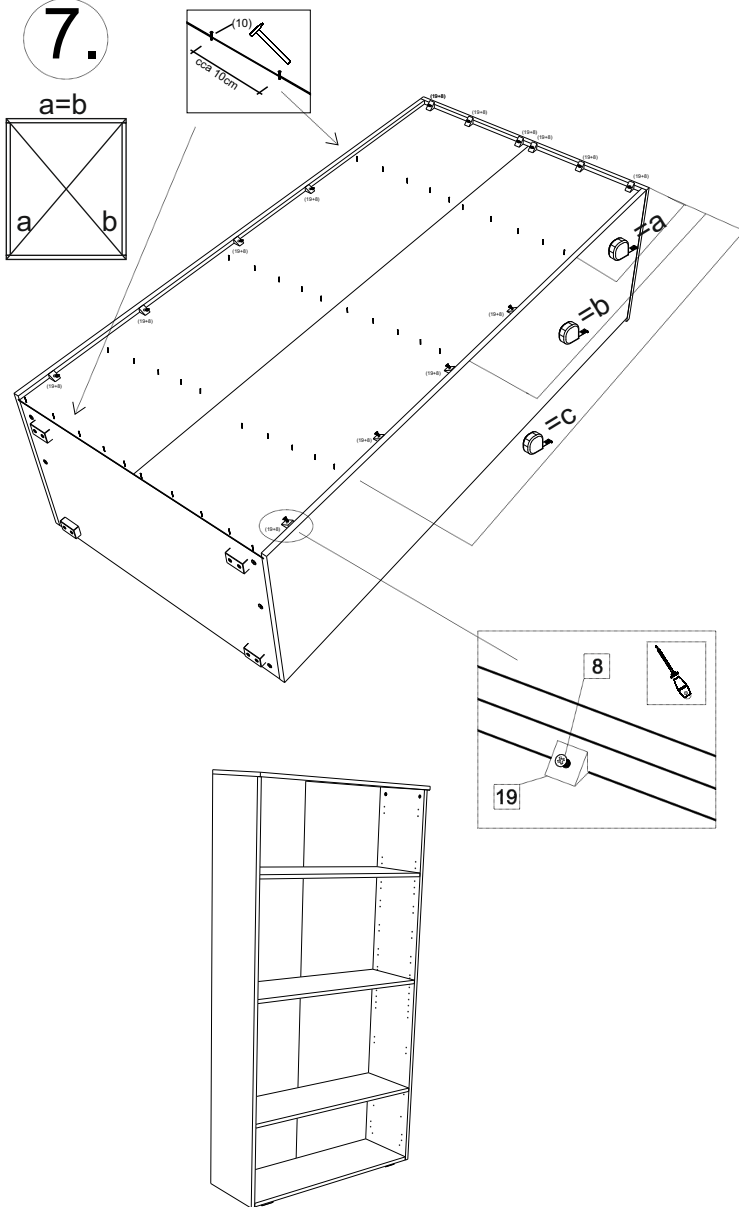

8.

