

**DREVONA®**  
S Y S T E M**Michaela**  
**M-06**

	960
	1000
	370

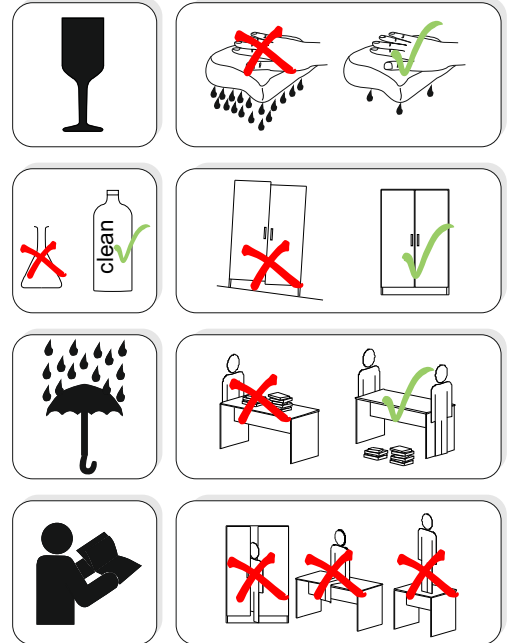

1		2		3		4		8		9		10	
tiahlo	8ks	excenter	8ks	kolík 8x35	8ks	krytka	4ks	skrutka zh 3x20	8ks	skrutka zh 5x25	8ks	klinec 1,2x25	12ks
12		13		14		19							
kľazak Herman	4ks	narážací excenter	4ks	kolík DU 322 (tiahlo)	4ks	chrbatova spojka	8ks						

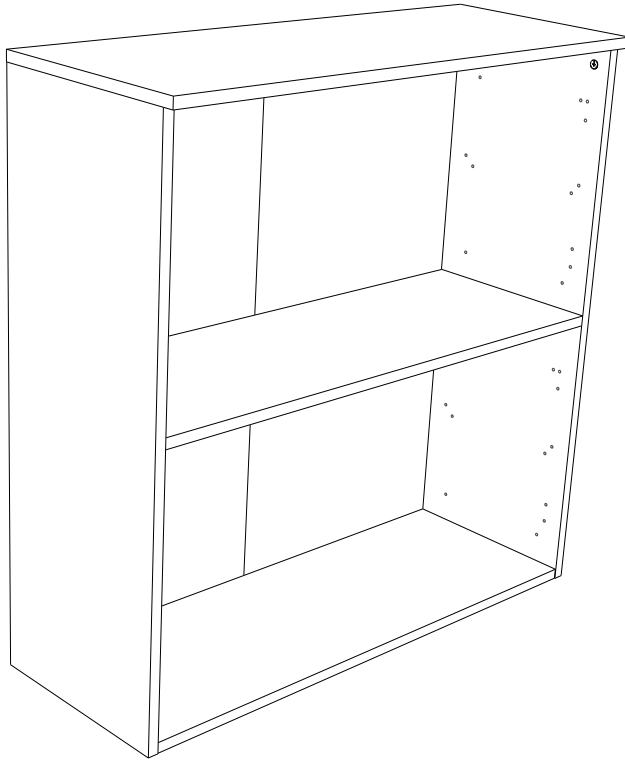
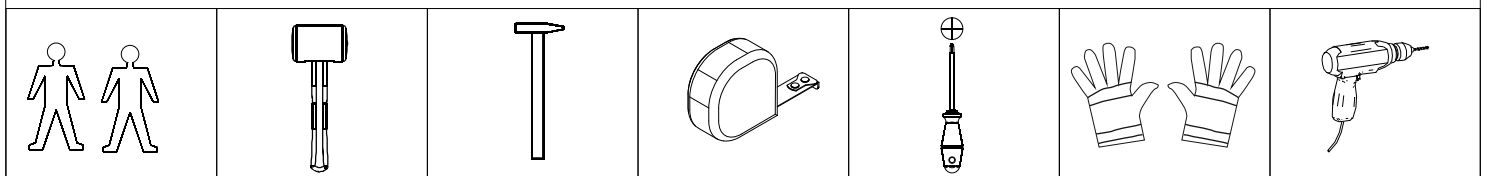

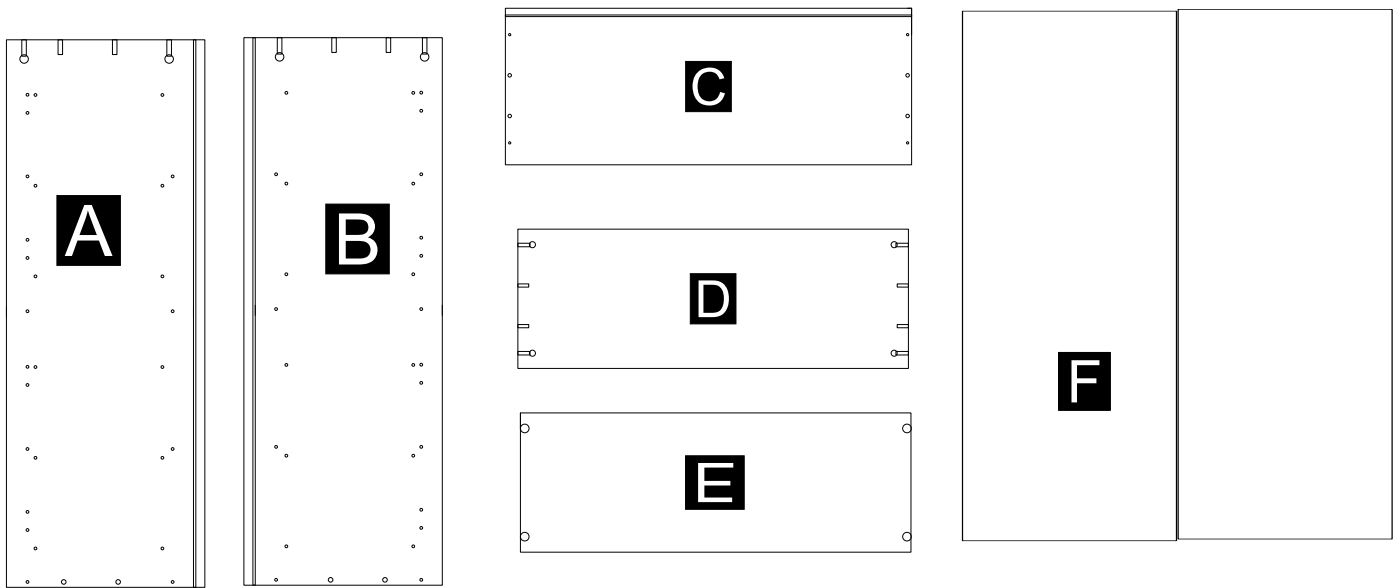

diel	hr	š	d	ks
A	18	350	966	1
B	18	350	966	1
C	18	370	960	1
D	18	329	923	1
E	18	329	923	1
F	3	466	970	2

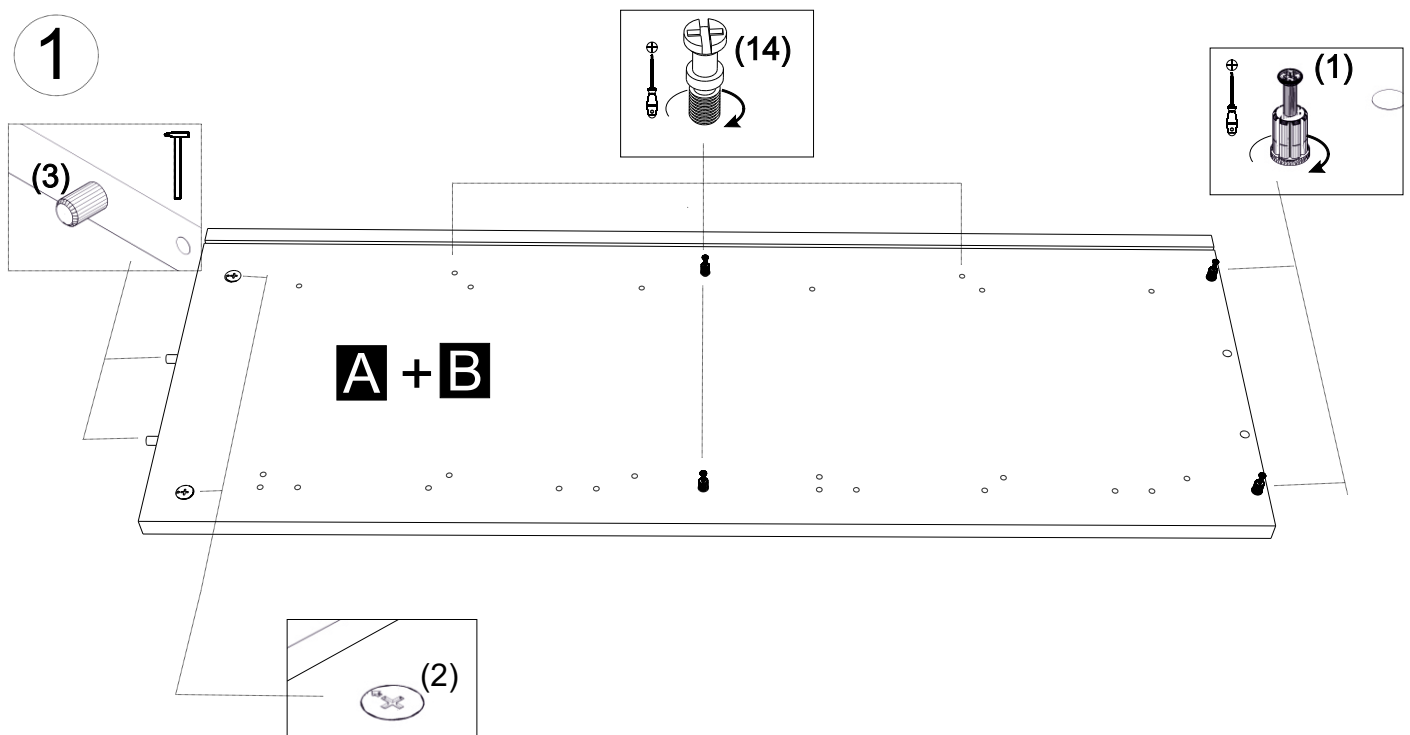

2.

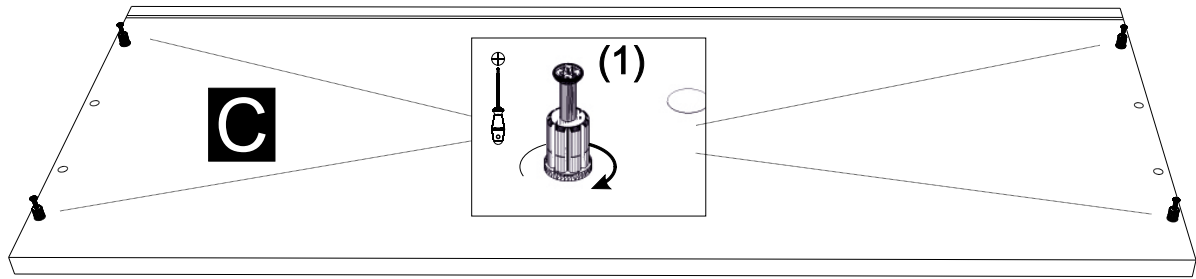

3.

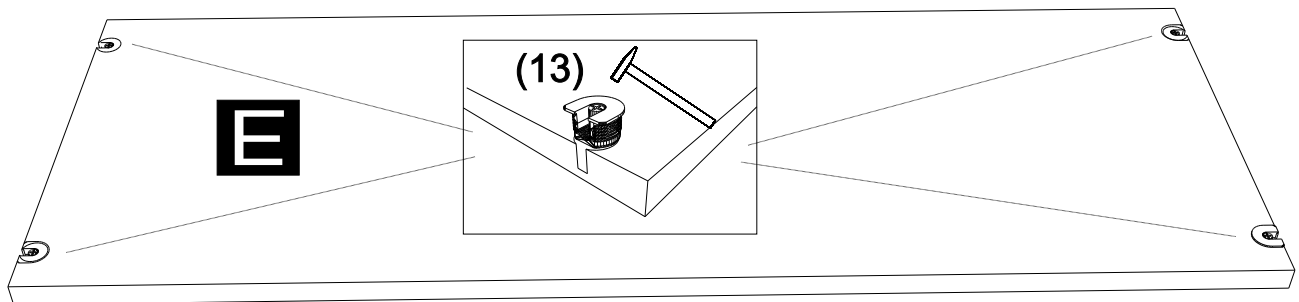

4.

I.

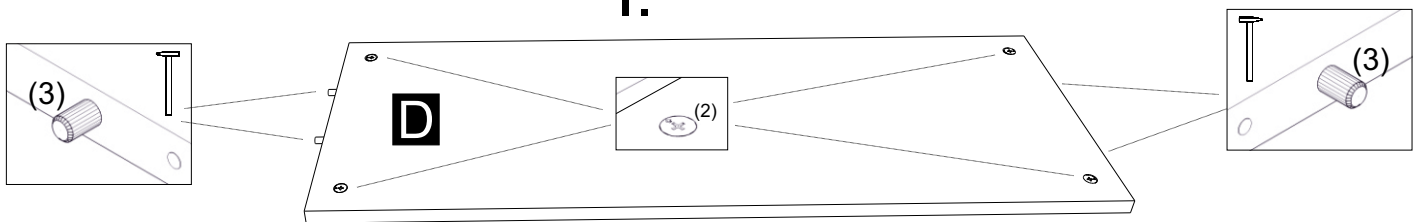

II.

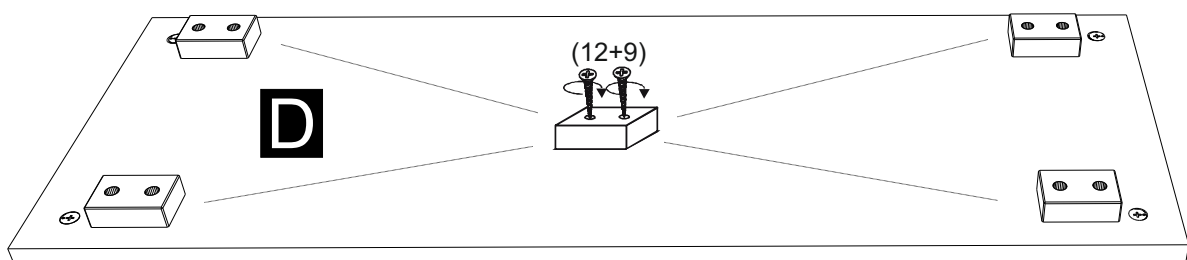

5.

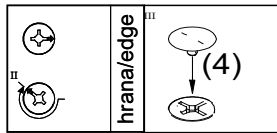
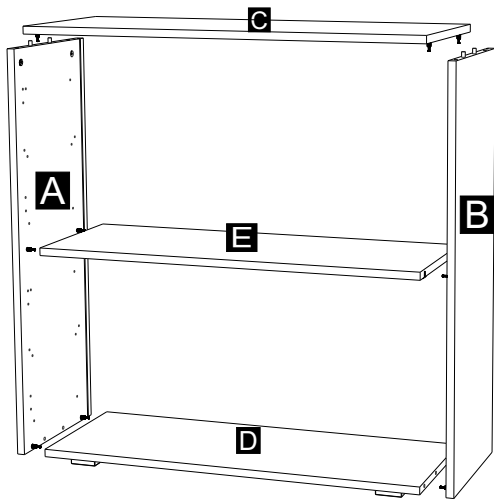

6.

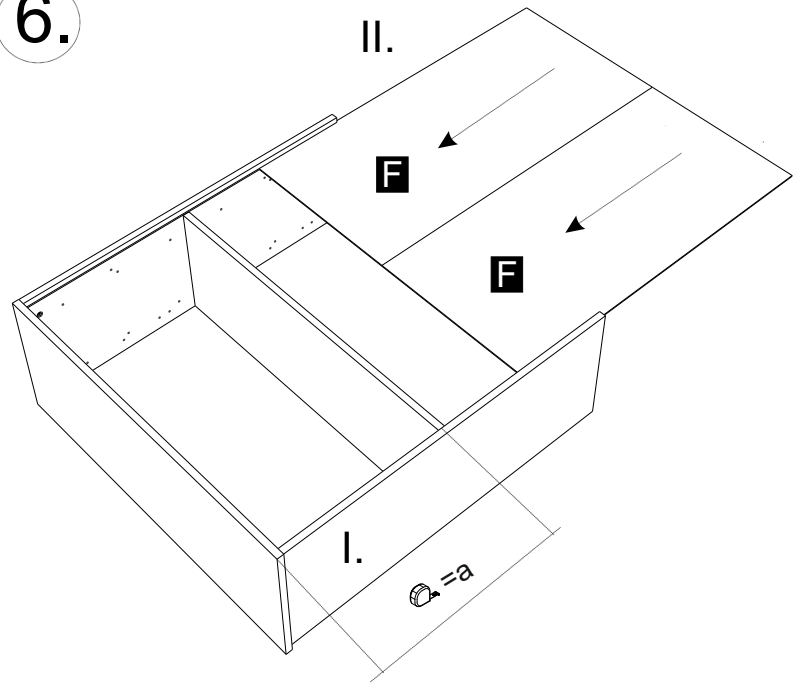

7.

