

DREVONA
S Y S T E M**Michaela
M-HL**

	955
	157
	510

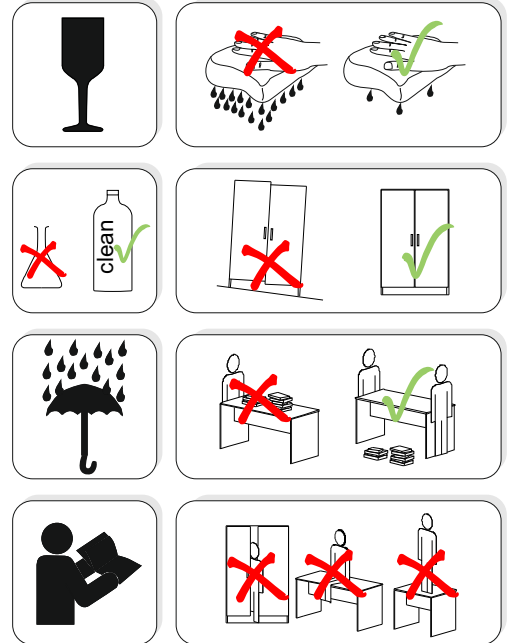
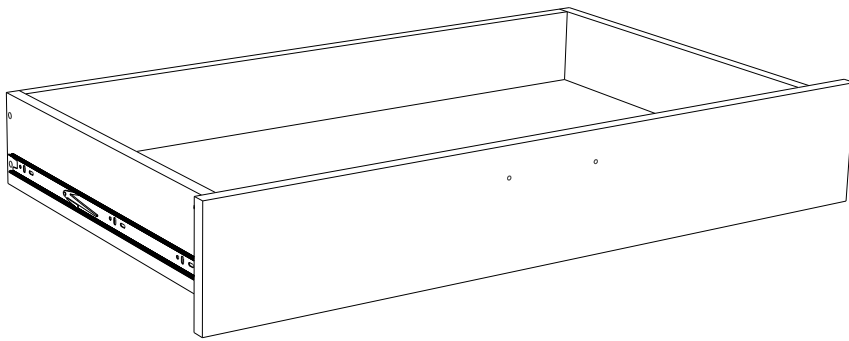

1		2		3		4		5		6		7	
ťahlo	4ks	excenter	4ks	konfirmát 7x50	4ks	krytka	2ks	skrutka zh 3,5x16	6ks	skrutka zh 3x20	4ks	chrbatova spojka	4ks

8		9		10		11		18	
plinový súv 500	1pár	Úchytka Sisa 128mm	1ks	Skrutka M4x22	2ks	euroskrutka 6,3x11	6ks	ímбусový kľúč „4“	1ks

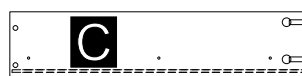
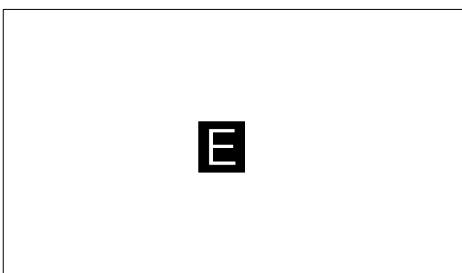

diel	hr	š	d	ks
A	18	157	955	1
B	18	120	510	1
C	18	120	510	1
D	18	120	861	1
E	3	503	872	1

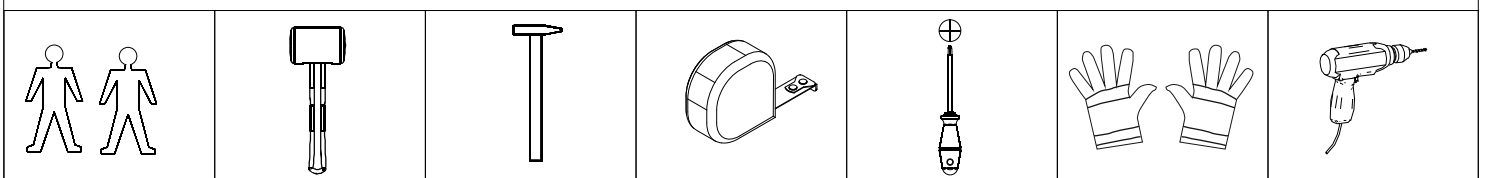

1

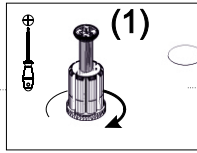
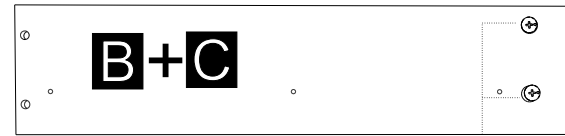
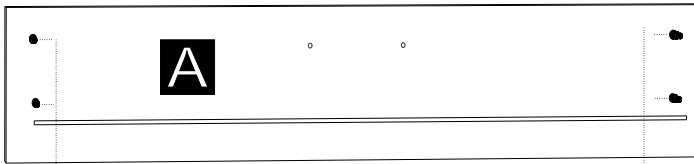

2

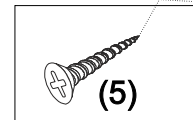
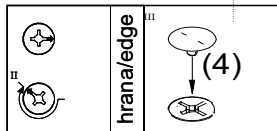
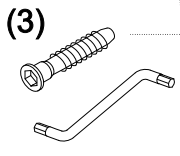
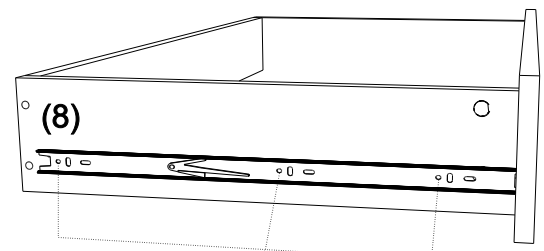
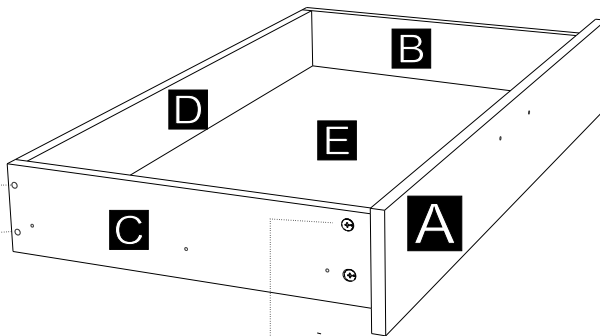

3

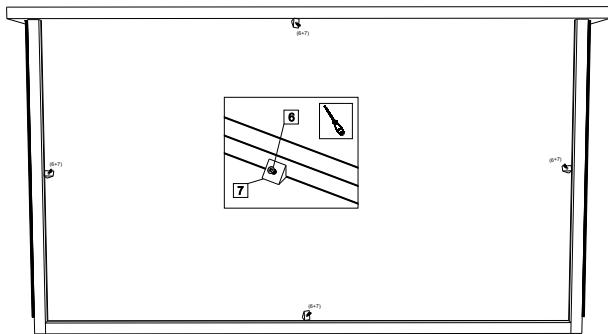

4

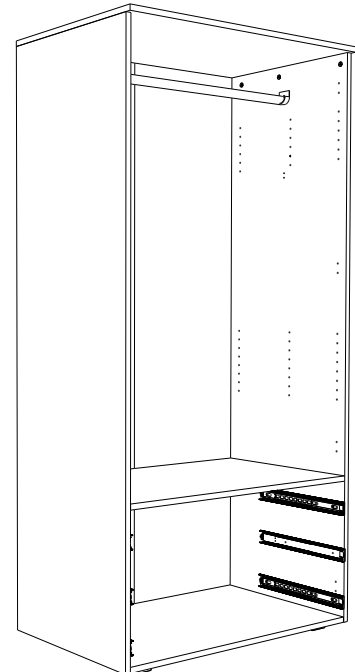

5

