

**avaks**  
nábytok

# ROXI

## korpus 160

|  |      |
|--|------|
|  | 1654 |
|  | 477  |
|  | 2050 |

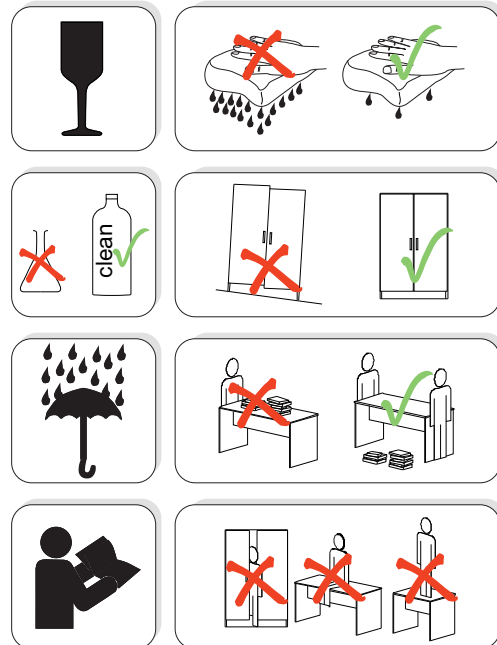
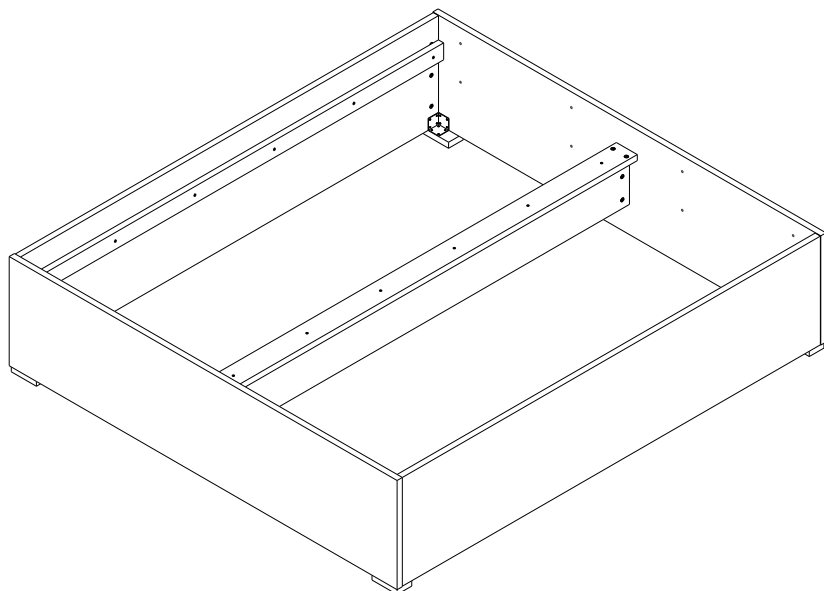

1/1

|                             |      |                      |      |          |      |                    |     |                          |      |                  |      |               |     |
|-----------------------------|------|----------------------|------|----------|------|--------------------|-----|--------------------------|------|------------------|------|---------------|-----|
| <b>1</b>                    |      | <b>2</b>             |      | <b>3</b> |      | <b>4</b>           |     | <b>5</b>                 |      | <b>6</b>         |      | <b>7</b>      |     |
| kolík<br>8x35               | 22ks | tiahlo               | 20ks | excenter | 20ks | skrutka zh<br>4x50 | 6ks | narážacia<br>hmoždina M6 | 12ks | skrutka<br>M6x35 | 12ks | Noha<br>Eamon | 4ks |
| <b>8</b>                    |      | <b>9</b>             |      |          |      |                    |     |                          |      |                  |      |               |     |
| spojovací plech<br>50x50x50 | 4ks  | skrutka zh<br>3,5x16 | 48ks |          |      |                    |     |                          |      |                  |      |               |     |

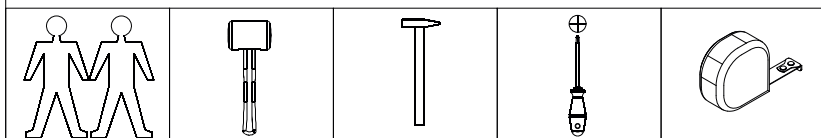

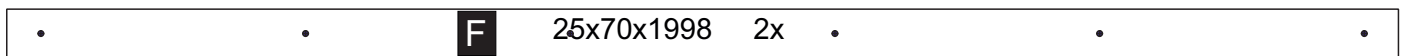
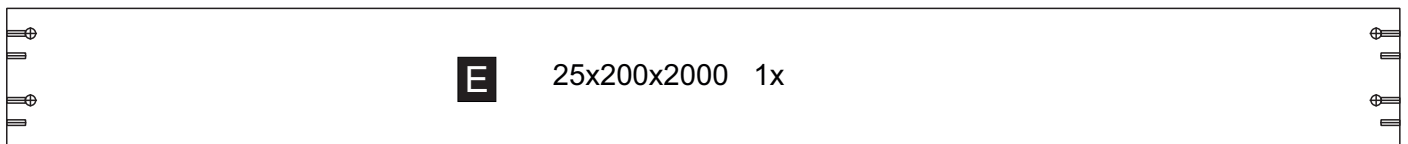
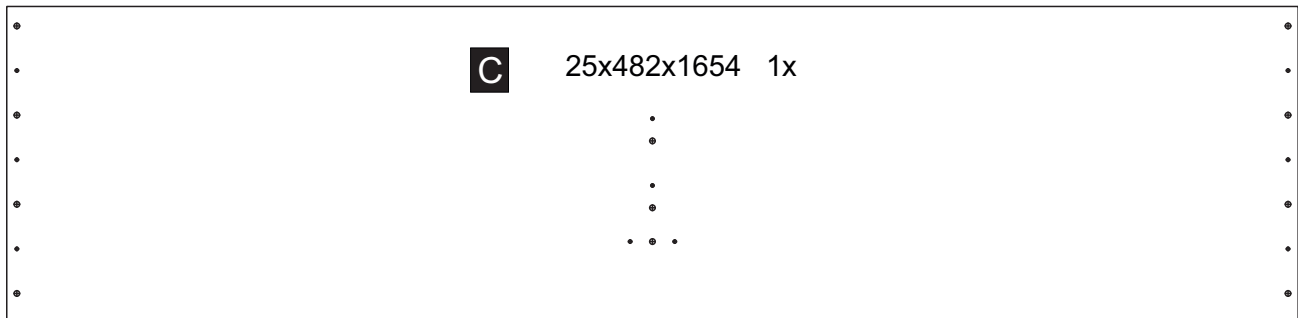
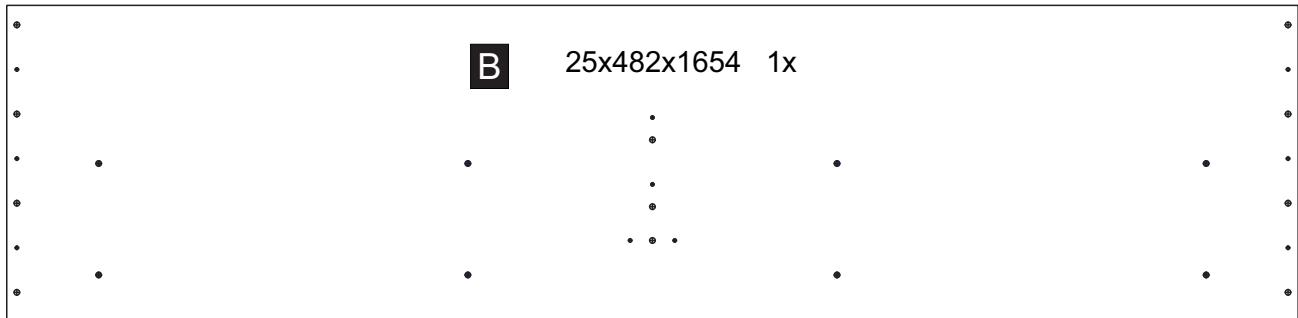
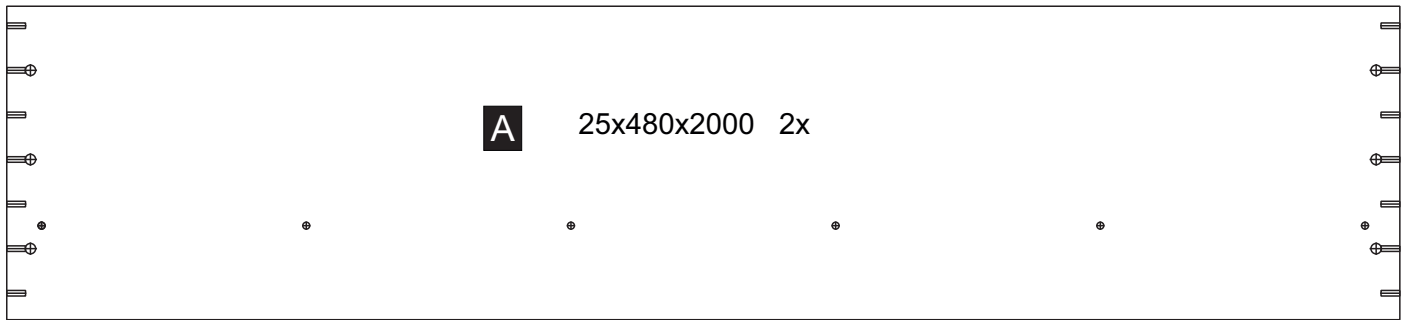

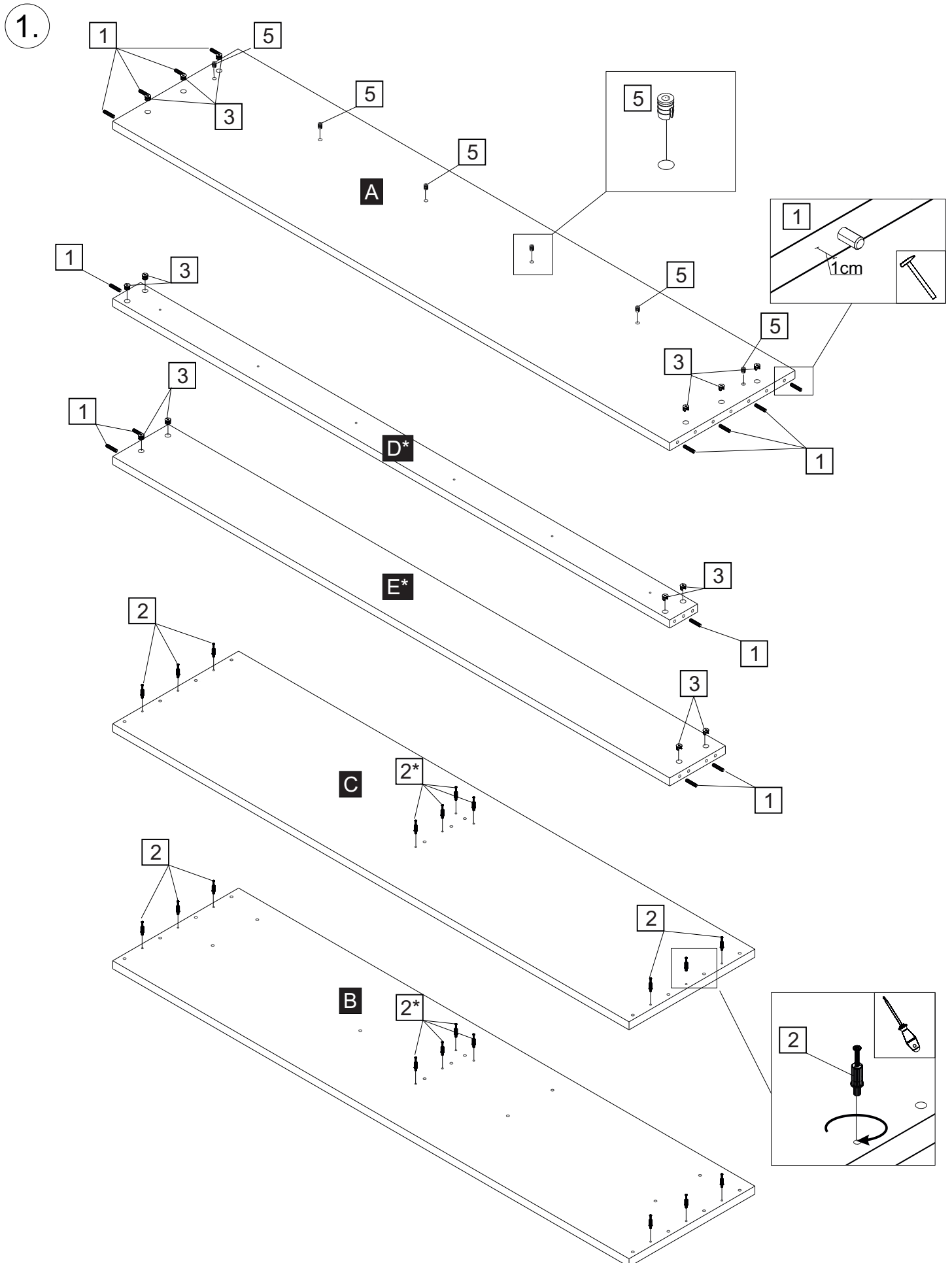

\*pri montáži s úložným priestorom vynechať

2.

montáž bez úložného priestoru

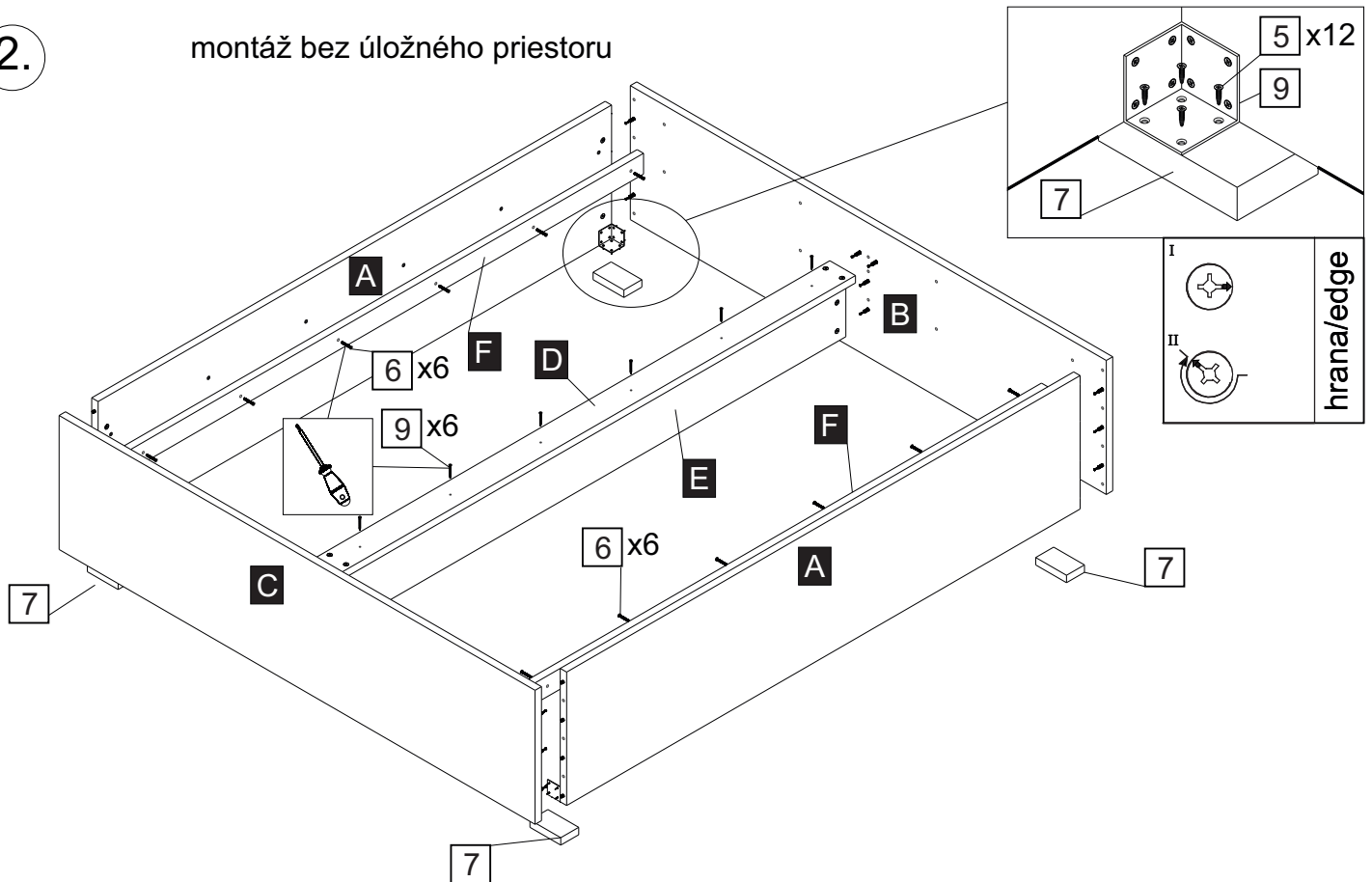

2.

montáž s úložným priestorom

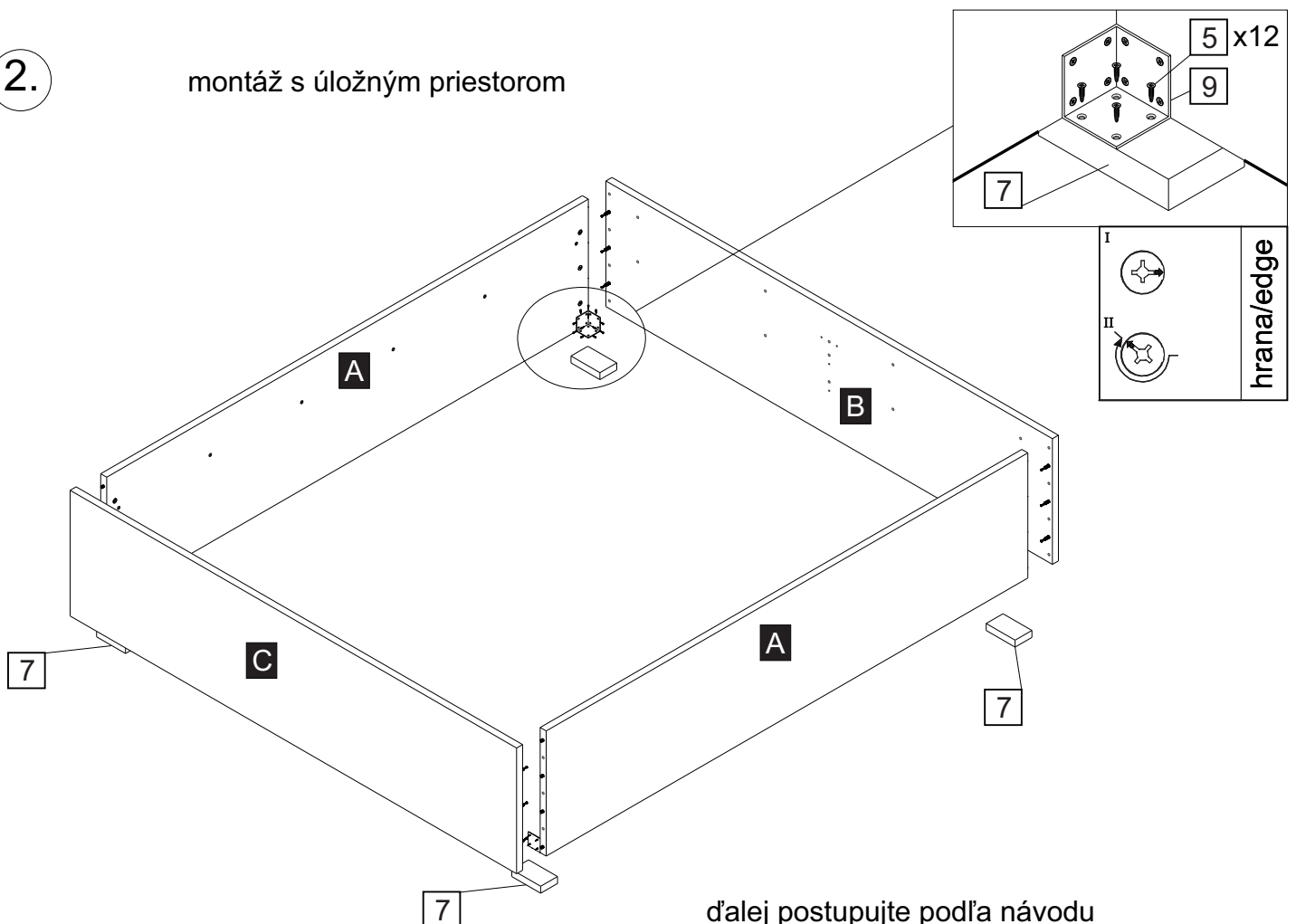
ďalej postupujte podľa návodu  
priloženému k úložnému priestoru